

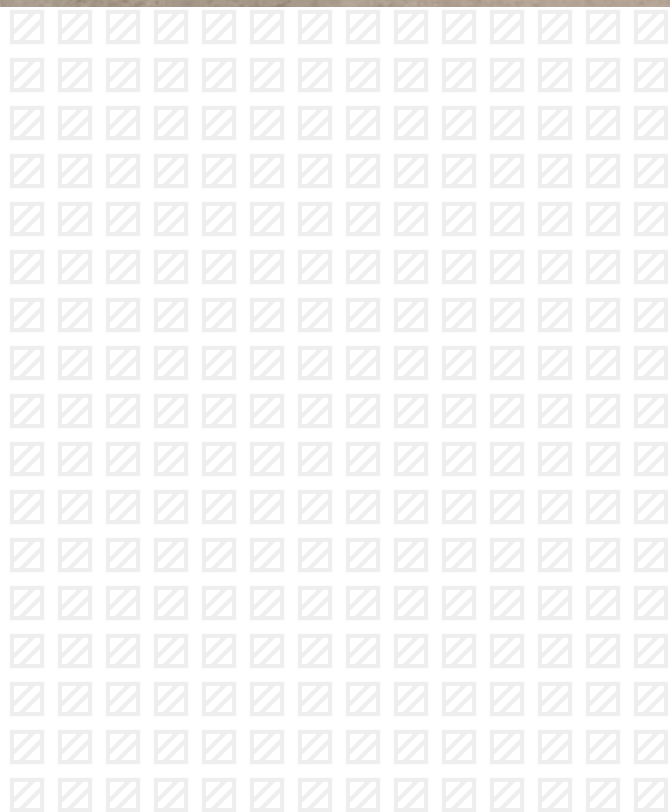

STONE & CLASSIC
COLLECTION



MEDITERRANEA



 **Tagina**
ITALY'S BEST SURFACES

MEDITERRANEA

Ieri, oggi e domani: la storia, la contemporaneità e lo stile intramontabile dei panorami mediterranei sono le caratteristiche di **MEDITERRANEA**. Una collezione che si ispira alla pietra lì protagonista che, rimasta nuda allo sguardo, viene scaldata dal sole e levigata dalla natura. Una pietra dalle varie facce per le sue molte origini i cui bordi, lavorati dal tempo, le donano una profondità ed una personalità unica. Una pietra che sa essere classica e moderna allo stesso tempo, ricca di storia ma anche fonte di ispirazione per immaginare il futuro.

Yesterday, today, and tomorrow: the history, the modernity, and the timeless style of the Mediterranean landscapes are the traits of **MEDITERRANEA**. A collection inspired by the characteristic stone of that area, which, left naked to the eye, is warmed by the sun and smoothed by nature. A stone with many facets due to its many origins, whose edges, worn by time, give it a unique depth and personality. A stone that is classic and modern at the same time, rich in history but also a source of inspiration to imagine the future.

Hier, aujourd'hui et demain : l'histoire, la contemporanéité et le style intemporel des paysages méditerranéens sont les caractéristiques de **MEDITERRANEA**. Une collection inspirée par la pierre qui en est le protagoniste, laissée à nu, réchauffée par le soleil et polie par la nature. Une pierre aux multiples faces en raison de ses nombreuses origines, dont les arêtes, travaillées par le temps, lui donnent de la profondeur et une personnalité unique. Une pierre qui sait être à la fois classique et moderne, riche en histoire mais aussi source d'inspiration pour imaginer l'avenir.

Gestern, heute und morgen: Geschichte, Aktualität und der zeitlose Stil der mediterranen Landschaften sind die charakteristischen Merkmale von **MEDITERRANEA**. Eine Kollektion, die vom Stein inspiriert ist, dem Protagonisten, der sich in seiner Natürlichkeit präsentiert, von der Sonne erwärmt und von der Natur geglättet. Ein Stein mit vielen Gesichtern dank seiner vielfältigen Ursprünge, dessen von der Zeit geprägte Kanten ihm eine einzigartige Tiefe und Persönlichkeit verleihen. Ein Stein, der klassisch und modern zugleich ist, reich an Geschichte, aber auch eine Quelle der Inspiration für die Zukunft.

100% Made in Italy



SCALE / STAIRS
DOR 90x90 Nat. Ret.
Coprispigolo triangolare DOR 1,4x90



Erice Nat. Ret.
Modulo D4









7

INDOOR
MENFI 90x90 Nat. Ret.

OUTDOOR
MENFI 60x90 Nat. Ret. R11



MENFI 60x90 Nat. Ret.
AMELIA "B" 20x20 Nat. Ret.
AMELIA "B" 60x90 Nat. Ret.



AMELIA "B" 20x20 Nat. Ret.
Coprispigolo Triangolare MENFI 1,4x90









BYBLOS 60x90 20 mm Nat. Ret. R11
AMELIA VINTAGE "A" 60x90 20 mm Nat. Ret. R11
AMELIA "A" 20x20 Nat. Ret.





MEDITERRANEA

Ogni collezione Tagina rivela la massima cura e una sensibilità artistica raffinata capace di riprodurre la più intima essenza estetica della materia.

Colori e trame ricercate si sommano a caratteristiche tecniche di massima qualità grazie alle tecnologie produttive più avanzate.

Una superficie Tagina è garanzia di eccellenza e prestigio in ogni genere di spazio legato a emozioni inalterabili nel tempo.

Every Tagina collection shows the utmost attention to detail and a sophisticated artistic sensitivity that reproduces the most intimate aesthetic essence of the material. Refined colours and textures combine with the highest-quality technical characteristics thanks to the most advanced manufacturing technologies.

A Tagina surface is a guarantee of excellence and prestige in any kind of environment connected to emotions impervious to time.

Chaque collection Tagina révèle un soin maximal et une sensibilité artistique raffinée capable de reproduire l'essence esthétique la plus intime de la matière.

Couleurs et motifs recherchés s'ajoutent à des caractéristiques techniques d'une qualité maximale grâce aux technologies de production les plus avancées.

Une surface Tagina est une garantie d'excellence et de prestige dans tous les types d'espace lié à des émotions inaltérables dans le temps.

Jede Tagina-Kollektion zeugt von größter Sorgfalt und einem raffinierten künstlerischen Gespür, das die intimste ästhetische Essenz des Materials wiederzugeben vermag. Raffinierte Farben und Texturen ergänzen sich durch modernste Produktionstechnologien mit hochwertigen technischen Eigenschaften.

Eine Oberfläche von Tagina ist eine Garantie für Exzellenz und Wertigkeit in jeder Art von Raum, verbunden mit dauerhaften Emotionen.



Modularità / Modularity / Modularité / Modularität

MODULO

- D2** 40x60 - 33,33%
 40x40 - 44,44%
 20x40 - 11,11%
 20x20 - 11,11%

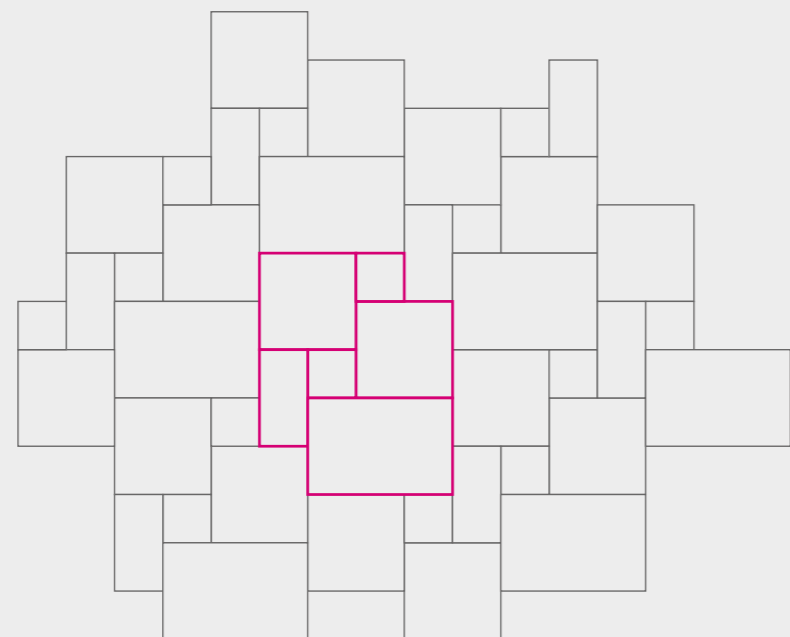

La collezione MEDITERRANEA è estremamente versatile: coi suoi molteplici formati, tutti rettificati, si possono comporre moduli a 3 o 4 formati con fuga 2 mm.

The MEDITERRANEA collection is extremely versatile: with its multiple sizes, all rectified, you can compose modules with 3 or 4 sizes with a joint size of 2 mm.

La collection MEDITERRANEA est extrêmement flexible : avec ses multiples formats, tous rectifiés, il est possible de composer des modules à 3 ou 4 formats avec un joint de 2 mm.

Die Kollektion MEDITERRANEA ist äußerst vielseitig: Mit ihren zahlreichen rektifizierte Formaten lassen sich 3- oder 4-formatige Module mit einem Fugenmaß von 2 mm herstellen.

Modularità / Modularity / Modularité / Modularität

MODULO

- D3** 40x60 - 46,15%
 40x40 - 30,77%
 20x40 - 15,38%
 20x20 - 7,69%

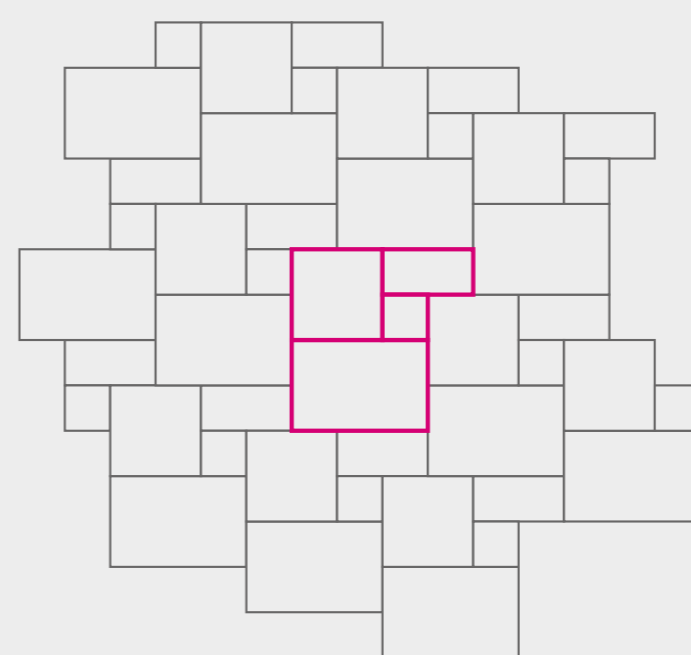

Modularità / Modularity / Modularité / Modularität

MODULO

- D4** 40x60 - 40,00%
 40x40 - 40,00%
 20x40 - 13,33%
 20x20 - 6,67%

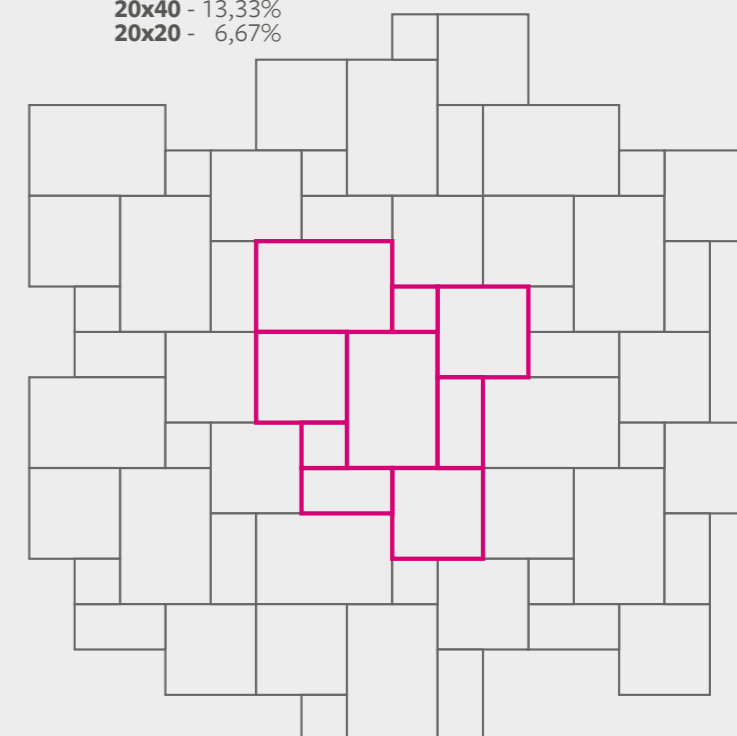

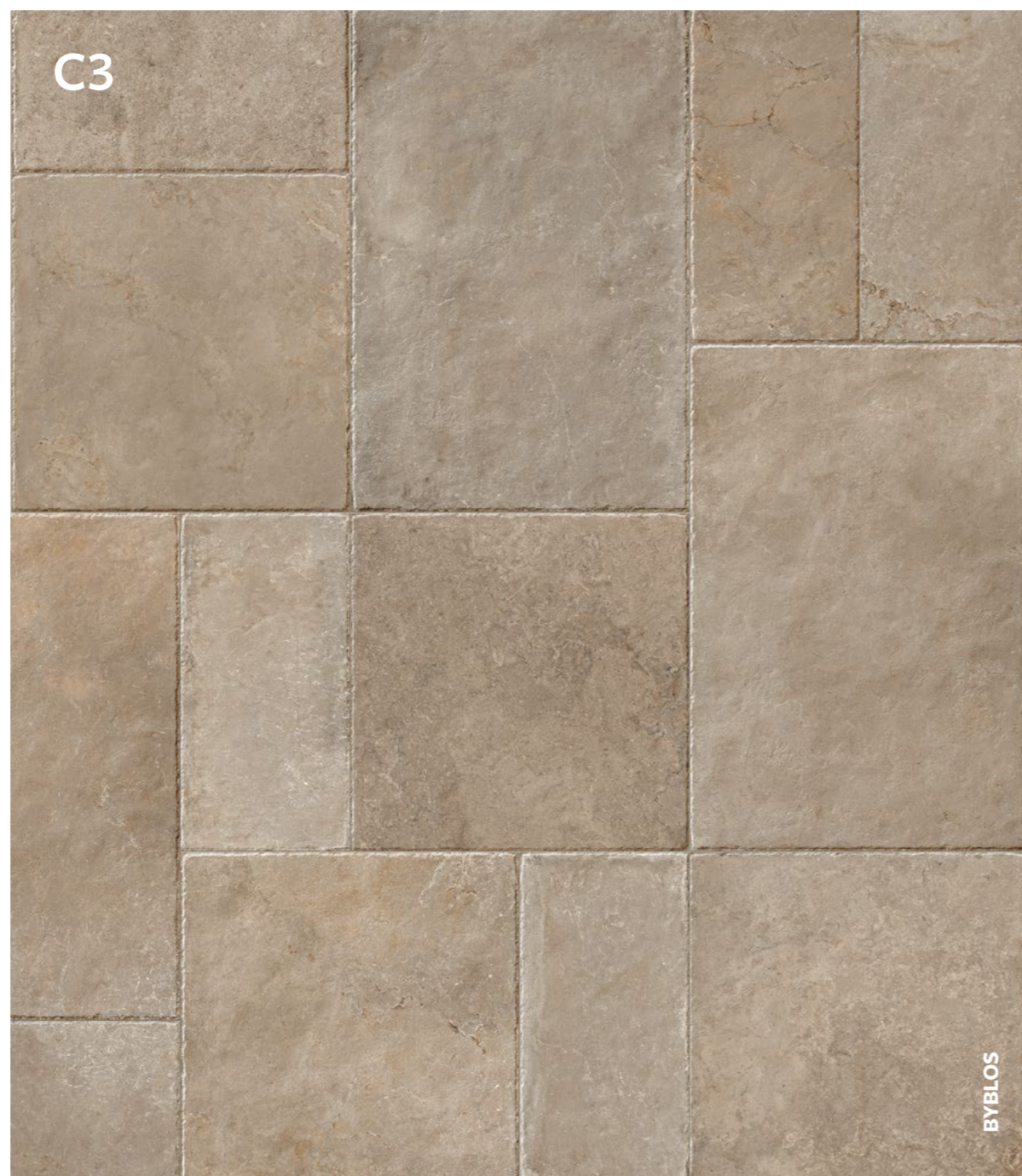

Modularità / Modularity / Modularité / Modularität

MODULO

C3 60x90 - 50,00%
60x60 - 33,33%
30x60 - 16,67%

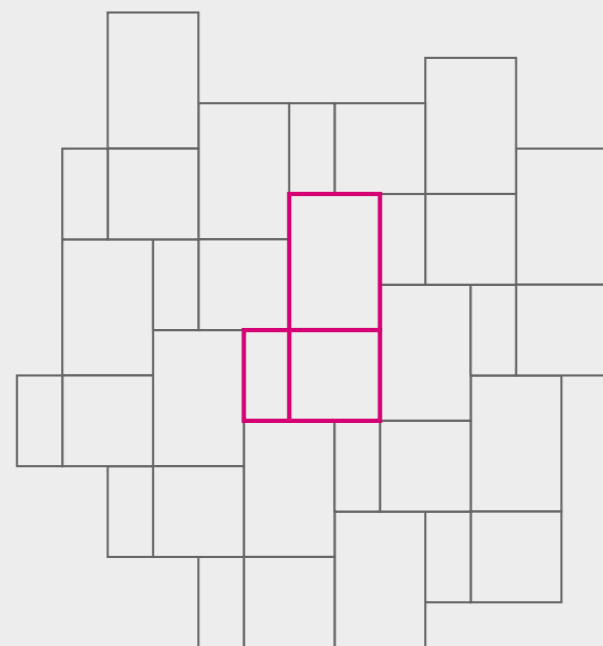

La collezione MEDITERRANEA è estremamente versatile: coi suoi molteplici formati, tutti rettificati, si possono comporre moduli a 3 o 4 formati con fuga 2 mm.

The MEDITERRANEA collection is extremely versatile: with its multiple sizes, all rectified, you can compose modules with 3 or 4 sizes with a joint size of 2 mm.

La collection MEDITERRANEA est extrêmement flexible : avec ses multiples formats, tous rectifiés, il est possible de composer des modules à 3 ou 4 formats avec un joint de 2 mm.

Die Kollektion MEDITERRANEA ist äußerst vielseitig: Mit ihren zahlreichen rektifizierte Formaten lassen sich 3- oder 4-formatige Module mit einem Fugenmaß von 2 mm herstellen.

Modularità / Modularity / Modularité / Modularität

MODULO

C4 60x90 - 50,00%
60x60 - 33,33%
30x60 - 16,67%

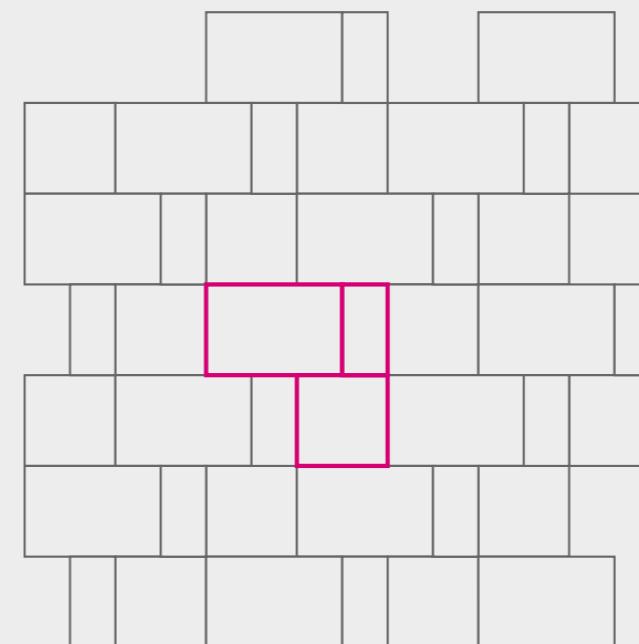

Spessore . Thickness . Epaisseur . Stärke - 10 mm / 20 mm R11
Gres porcellanato colorato in massa. Full-body coloured porcelain stoneware. Grès cérame coloré dans la masse. In der Masse gefärbtes Feinsteinzeug.

DECORI
 Decors / Décors / Dekore

10 mm . 20x20 - 8"x8"

AMELIA "A"

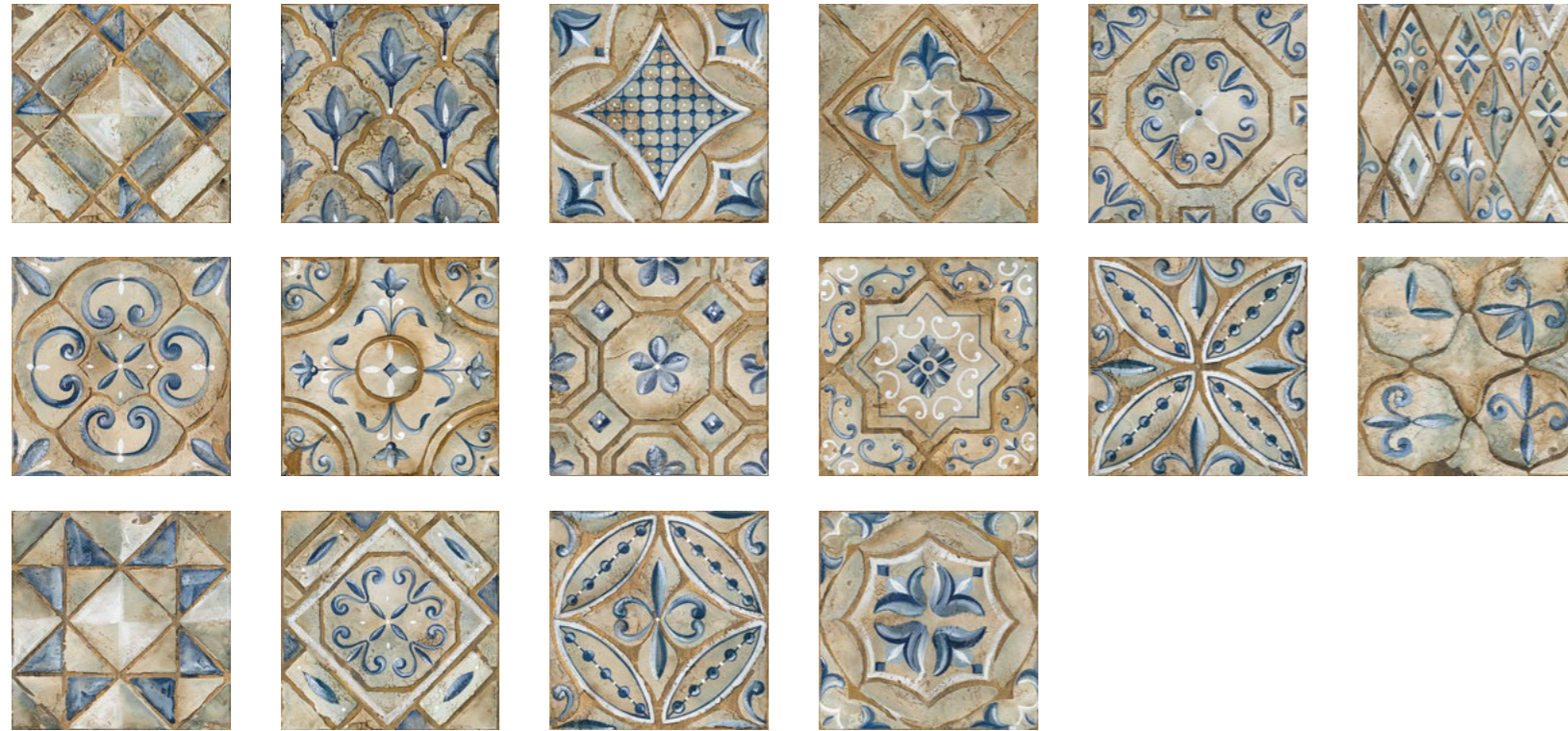

10 mm . 20x20 - 8"x8"

AMELIA "B"



10 mm . 60x90 - 24"x35 1/2"

AMELIA "A"



AMELIA "B"

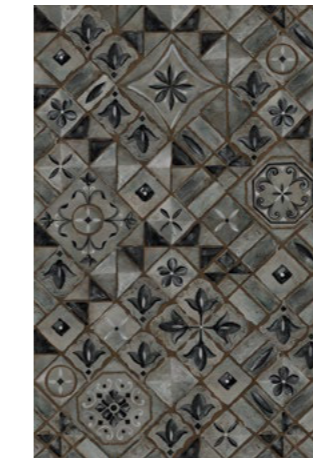
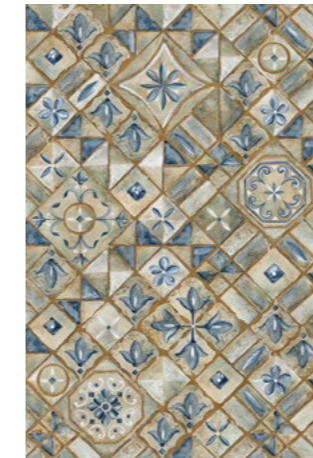

20 mm R11 . 60x90 - 24"x35 1/2"

AMELIA VINTAGE "A"

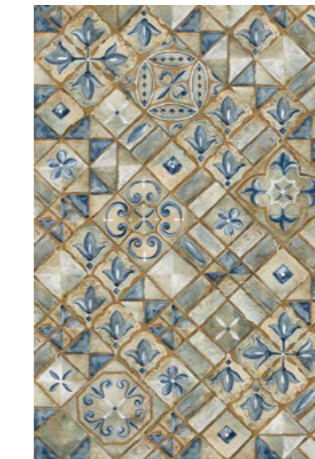

AMELIA VINTAGE "B"

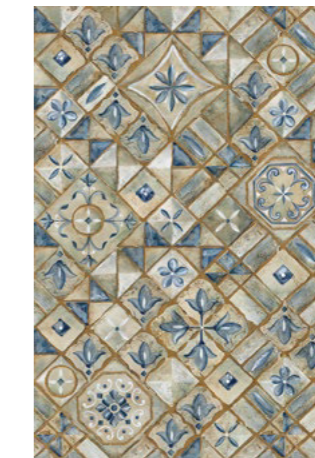

All'interno delle scatole il mix dei soggetti del decoro è del tutto casuale. In alcune scatole qualche soggetto potrebbe ripetersi.
 The mix of decor patterns within each box is entirely random. Some of the decor patterns within each box may be the same.
 A l'intérieur des boîtes le mélange des sujets de décoration est complètement aléatoire. Dans certaines boîtes parfois les sujets peuvent se répéter.
 Im Inneren der Kartons kommt die Mischung der Motive einzelner Dekore völlig zufällig vor. In einigen Kartons können sich einige Motive wiederholen.

I Decori Amelia si abbinano al fondo ma possono essere di tonalità diversa.
 Amelia Decors match the base but may be of a different tone.
 Les décors Amelia sont assortis au fond, mais les tonalités peuvent être différentes.
 Die Dekore Amelia passen zum Unifliese, können jedoch unterschiedliche Farbtöne aufweisen.

FORMATI

Sizes / Formats / Formate

- 10 mm .** 90x90 - 35½"x35 ½" / 60x90 - 24"x35 ½" / 60x60 - 24"x24" / 30x60 - 12"x24"
 40x60 - 16"x24" / 40x40 - 16"x16" / 20x40 - 8"x16" / 20x20 - 8"x8"
10 mm R11 . 60x90 - 24"x35 ½" / 40x60 - 16"x24" / 40x40 - 16"x16" / 20x40 - 8"x16" / 20x20 - 8"x8"
20 mm R11 . 90x90 - 35½"x35 ½" / 60x90 - 24"x35 ½"

COLORI

Colours / Couleurs / Farben



BYBLOS



DOR



ERICE



MENFI

CONTINUITÀ PROGETTUALE INDOOR-OUTDOOR

Design continuity indoors and out / Continuité conceptuelle à l'intérieur et à l'extérieur / Entwurfskontinuität im innen- und Aussenbereich



INDOOR



Soluzioni contemporanee per l'interior design
 Contemporary solutions for interior design.
 Solutions contemporaines pour le design intérieur.
 Zeitgemäße Lösungen für das Interior Design.

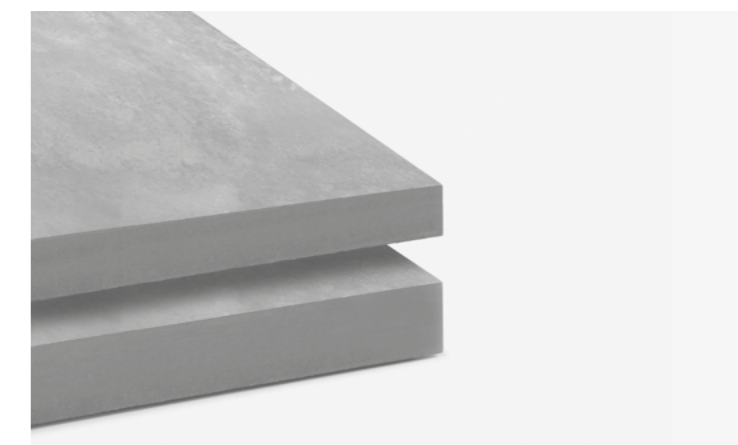

OUTDOOR



Versatilità e prestazioni per la progettazione in esterna
 Versatility and performance for outdoor design.
 Polyvalence et performance pour l'aménagement extérieur.
 Vielseitigkeit und Leistungen für Outdoor-Design.

SISTEMI DI POSA

Laying systems / Systemes de pose / Verlegearten

Posa su erba
 Laying on grass
 Pose sur l'herbe
 Verlegung auf Wiese

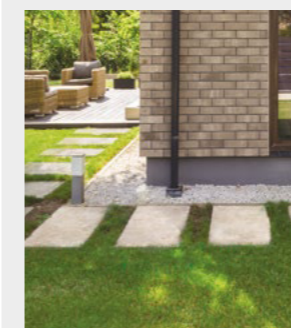

Posa su sabbia
 Laying on sand
 Pose sur sable
 Verlegung auf Sand



Posa sopraelevata
 Raised laying
 Pose surélevée
 Verlegung auf Stelzlagern



Posa su ghiaia
 Laying on gravel
 Pose sur gravier
 Verlegung auf Kies



Posa tradizionale
 Standard laying
 Pose traditionnelle
 Herkömmliche Verlegung

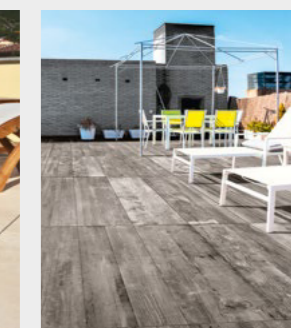

Spessore . Thickness . Epaisseur . Stärke - 10 mm

Gres porcellanato colorato in massa. Full-body coloured porcelain stoneware. Grès cérame coloré dans la masse. In der Masse gefärbtes Feinsteinzeug.

INDOOR

TABELLA RIEPILOGATIVA
Summary table
Tableau récapitulatif
Zusammenfassende Tabelle

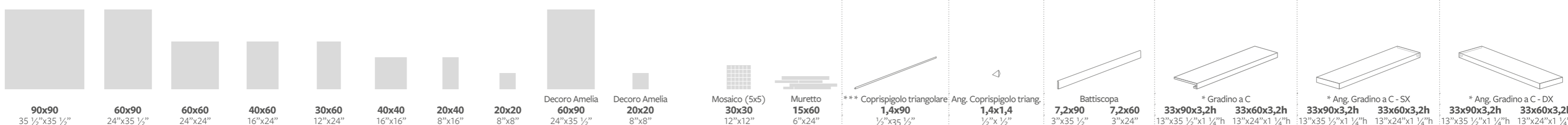

SPESSORE - THICKNESS - EPAISSEUR - STÄRKE		10 mm	10 mm	10 mm	10 mm	10 mm	10 mm	10 mm	10 mm	10 mm	10 mm	10 mm	10 mm	10 mm	10 mm	10 mm	10 mm	10 mm	10 mm	10 mm	10 mm	10 mm	10 mm		
	DOR □ Nat. Ret.	128015	128025	128035	128045	128055	128065	128075	128085	(A) 128090	(A) 128092			128301	128311	128401	128411	128101	128111	128201	128211	128231	128251	128221	128241
	BYBLOS □ Nat. Ret.	128016	128026	128036	128046	128056	128066	128076	128086					128302	128312	128402	128412	128102	128112	128202	128212	128232	128252	128222	128242
	ERICE □ Nat. Ret.	128017	128027	128037	128047	128057	128067	128077	128087	(B) 128091	(B) 128093			128303	128313	128403	128413	128103	128113	128203	128213	128233	128253	128223	128243
	MENFI □ Nat. Ret.	128018	128028	128038	128048	128058	128068	128078	128088					128304	128314	128404	128414	128104	128114	128204	128214	128234	128254	128224	128244
																								324P € 173,34/pc	
		Pallet	Pallet	Pallet	Pallet	Pallet	Pallet	Pallet	Pallet	Pallet	Pallet	Pallet	Pallet					Pallet	Pallet	Pallet	Pallet	Pallet	Pallet	Pallet	
		94x120	93x120	80x120	80x120	80x120	80x120	80x120	80x120	93x120	80x120	80x120	80x120					80x120	80x120	80x120	80x120	80x120	80x120	80x120	
	N°																								
	m²																								
	** Kg																								
		2	2	3	4	6	6	8	16	2	16	11	3	6				8	14	2	4	1	2	1	2
	m² x	1,62	1,08	1,08	0,96	1,08	0,96	0,64	0,64	1,08	0,64	0,99	0,27					12	14,5	16,5	22	8,25	11	8,25	11
	Kg x	33,3	22,2	22,2	19,2	22,2	19,3	12,80	12,7	22,2	12,7	20	6	2				12	14,5	16,5	22	8,25	11	8,25	11
		20	48	40	48	40	60	72	72	48	72														
	m² x	32,4	51,84	43,2	46,08	43,2	57,6	46,08	46,08	51,84	46,08														
	** Kg x	686	1086	908	942	908	1178	942	934	1086	934														
	h x	65	73	73	73	73	94	73	73	73	73														
	Imballo (tara) - Packaging (tare)	(20)	(20)	(20)	(20)	(20)	(20)	(20)	(20)	(20)	(20)	(20)	(20)					(20)	(20)	(20)	(20)	(20)	(20)	(20)	(20)

I pesi riportati in tabella sono indicativi e potrebbero essere soggetti a leggere variazioni.
The weights stated in the chart may undergo slight changes for production reasons.
Les poids indiqués dans le tableau peuvent subir de légères variations pour des raisons de production.
Die in der Tabelle angegebenen Gewichte können aus Produktionsgründen geringfügigen Abweichungen unterliegen.

Non si garantisce l'abbinabilità tra fondi di spessori diversi e tra fondo e pezzo speciale.
It is not guaranteed that background tiles with different thicknesses can be used together, nor is it guaranteed for background tiles and trims.
Nous ne garantissons pas la possibilité de combiner des carrelages de sol de différentes épaisseurs et un carrelage de sol avec une pièce spéciale.
Die Kombinierbarkeit von Fliesen unterschiedlicher Stärke sowie zwischen Fliese und Formteil kann nicht garantiert werden.

* A disposizione solo su richiesta. Tempi di consegna 30 gg.
Available upon request only. Delivery terms: 30 days.
Disponible seulement sur requête. Délais de livraison: 30 jours.
Verfügbar auf Anfrage. Lieferzeit: 30 Tage.

** Il peso è comprensivo dell'imballo.
The total weight includes the packaging.
Le poids comprend aussi l'emballage.
Das Gesamtgewicht enthält auch die Verpackung.

*** Vendita a scatola completa.
Full box sale.
Vente à la boîte complète.
Volle Kartons.

Per le condizioni generali di vendita e le caratteristiche tecniche consultare www.tagina.it.
General terms and Sales conditions and Technical features are available on our website www.tagina.it.
Les Conditions général de vente et les Caractéristiques techniques sont disponibles sur le site web www.tagina.it.
Allgemeine Verkaufsbedingungen und technische Eigenschaften sind auf unsere Website verfügbar: www.tagina.it

□ Naturale e rettificato.
Natural and rectified.
Naturel et rectifié.
Natur Oberfläche und kalibriert.

Tagina S.p.A. si riserva di modificare, senza alcun preavviso, il packaging dei prodotti, le grafiche, i colori e i decori riportati nelle immagini che sono pertanto da ritenersi indicative.
Tagina S.p.A. reserves the right to change the product packaging, the patterns, colours and decorations shown in the pictures without any prior notice. These aspects, therefore should be considered for illustrative purposes only.
Tagina S.p.A. se réserve le droit de modifier, sans préavis, l'emballage des produits, les graphismes, les couleurs et les décors représentés dans les images, fournies à titre indicatif.
Die Tagina S.p.A. behält sich vor, die Verpackung der Produkte, die in den Abbildungen gezeigten Grafiken, Farben und Dekors sowie ohne vorherige Ankündigung zu ändern.

Spessore . Thickness . Epaisseur . Stärke - 10 mm R11 / 20 mm R11

Gres porcellanato colorato in massa. Full-body coloured porcelain stoneware. Grès cérame coloré dans la masse. In der Masse gefärbtes Feinsteinzeug.

OUTDOOR

TABELLA RIEPILOGATIVA
Summary table
Tableau récapitulatif
Zusammenfassende Tabelle

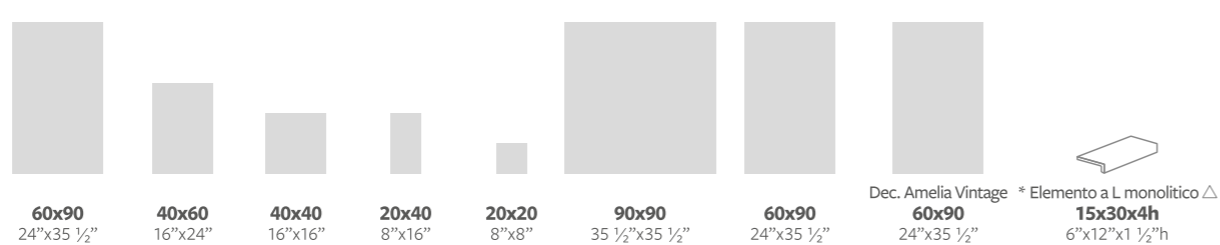

SPESSORE - THICKNESS - EPAISSEUR - STÄRKE		10 mm	10 mm	10 mm	10 mm	10 mm	20 mm	20 mm	20 mm	9,5 mm
DOR R11	□ Nat. Ret.	128021	128041	128061	128071	128081	128001	128005	(A) 128094	
	■ Nat. Nat.									128261
BYBLOS R11	□ Nat. Ret.	128022	128042	128062	128072	128082	128002	128006	(A) 128094	
	■ Nat. Nat.									128262
ERICE R11	□ Nat. Ret.	128023	128043	128063	128073	128083	128003	128007	(B) 128095	
	■ Nat. Nat.									128263
MENFI R11	□ Nat. Ret.	128024	128044	128064	128074	128084	128004	128008	(B) 128095	
	■ Nat. Nat.									128264
		Pallet	Pallet	Pallet	Pallet	Pallet	Pallet	Pallet	Pallet	Pallet
		93x120	80x120	80x120	80x120	80x120	94x94	93x120	93x120	80x120
N°										
m²										
** Kg										
		2	4	6	8	16	1	1	1	6
m² x		1,08	0,96	0,96	0,64	0,64	0,81	0,54	0,54	
Kg x		22,2	19,20	19,3	12,8	12,7	37	22,7	22,7	7,5
		48	48	60	72	72	30	50	50	
m² x		51,84	46,08	57,6	46,08	46,08	24,30	27	27	
** Kg x		1086	942	1178	942	934	1130	1162	1162	
h x		73	73	94	73	73	80			
Imballo (tara) - Packaging (tare)		(20)	(20)	(20)	(20)	(20)	(20)	(27)	(27)	(20)



BYBLOS 60x90 20 mm Nat. Ret. R11
AMELIA VINTAGE "A" 60x90 20 mm Nat. Ret. R11
AMELIA "A" 20x20 Nat. Ret.

I pesi riportati in tabella sono indicativi e potrebbero essere soggetti a leggere variazioni.
The weights stated in the chart may undergo slight changes for production reasons.
Les poids indiqués dans le tableau peuvent subir de légères variations pour des raisons de production.
Die in der Tabelle angegebenen Gewichte können aus Produktionsgründen geringfügigen Abweichungen unterliegen.

Non si garantisce l'abbinabilità tra fondi di spessori diversi e tra fondo e pezzo speciale.
It is not guaranteed that background tiles with different thicknesses can be used together, nor is it guaranteed for background tiles and trims.
Nous ne garantissons pas la possibilité de combiner des carrelages de sol de différentes épaisseurs et un carrelage de sol avec une pièce spéciale.
Die Kombinierbarkeit von Fliesen unterschiedlicher Stärke sowie zwischen Fliese und Formteil kann nicht garantiert werden.

* A disposizione solo su richiesta. Tempi di consegna 30 gg.
Available upon request only. Delivery terms: 30 days.
Disponible seulement sur requête. Délais de livraison: 30 jours.
Verfügbar auf Anfrage. Lieferzeit: 30 Tage.

** Il peso è comprensivo dell'imballo.
The total weight includes the packaging.
Le poids comprend aussi l'emballage.
Das Gesamtgewicht enthält auch die Verpackung.

□ Naturale e rettificato.
Natural and rectified.
Naturel et rectifié.
Natur Oberfläche und kalibriert.

■ Naturale e naturale.
Natural and natural.
Naturel et naturel.
Natur natur.

△ Monolitico
Monolithic step
Monolitico
Monolitische Stufenplatte

Spessore . Thickness . Epaisseur . Stärke - 20 mm R11

Gres porcellanato colorato in massa. Full-body coloured porcelain stoneware. Grès cérame coloré dans la masse. In der Masse gefärbtes Feinsteinzeug.



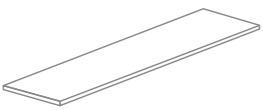
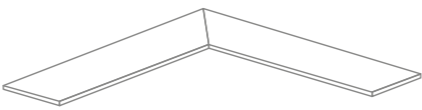
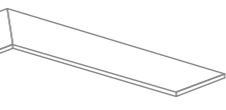

Pezzi speciali per esterno

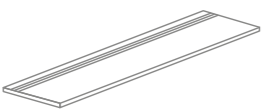
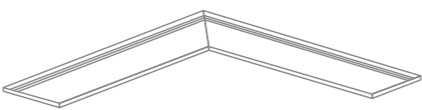
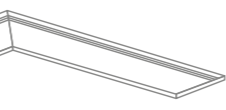
Special pieces for outdoor - Pièces spéciales pour extérieur - Formteile für Aussenbereich

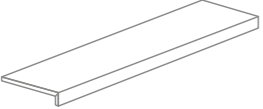
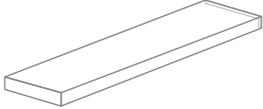
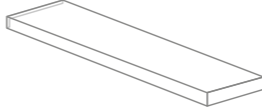
		
* Gradone □ Nat. Ret. 30x90 12"x35 1/2"	* Ang. Gradone - SX □ Nat. Ret. 30x90 12"x35 1/2"	* Ang. Gradone - DX □ Nat. Ret. 30x90 12"x35 1/2"
20 mm	20 mm	20 mm

		
* Gradone grip □ Nat. Ret. 30x90 12"x35 1/2"	* Ang. Gradone grip - SX □ Nat. Ret. 30x90 12"x35 1/2"	* Ang. Gradone grip - DX □ Nat. Ret. 30x90 12"x35 1/2"
20 mm	20 mm	20 mm

		
* Elemento a L □ Nat. Ret. 33x90x4h 13"x35 1/2"x1 1/2"h	* Elemento a L SX □ Nat. Ret. 33x90x4h 13"x35 1/2"x1 1/2"h	* Elemento a L DX □ Nat. Ret. 33x90x4h 13"x35 1/2"x1 1/2"h
20 mm	20 mm	20 mm

							
*** piedino regolabile 25-30	*** piedino regolabile 30-37	*** piedino regolabile 37-50	*** piedino regolabile 50-75	*** piedino regolabile 75-125	*** piedino regolabile 125-225	*** prolunga piedini h 100 mm	chiave di regolazione
600101	600102	600103	600104	600105	600106	600107	600108
	20	20	20	20	20	20	1

* A disposizione solo su richiesta. Tempi di consegna 30 gg.
Available upon request only. Delivery terms: 30 days.
Disponible seulement sur requête. Délais de livraison: 30 jours.
Verfügbar auf Anfrage. Lieferzeit: 30 Tage.

*** Vendita a scatola completa.
Full box sale.
Vente à la boîte complète.
Volle Kartons.

□ Naturale e rettificato.
Natural and rectified.
Naturel et rectifié.
Natur Oberfläche und kalibriert.

▮ Costa retta.
Straight edge.
Bord droit.
Gerade Kante.

▮ Costa toro.
Bullnose edge.
Bord boudin.
Abgerundete Kante.

Pezzi speciali per piscina

Special pieces for swimming pool - Pièces spéciales pour piscine - Formteile für Schwimmbad

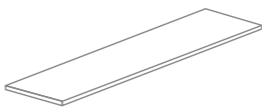
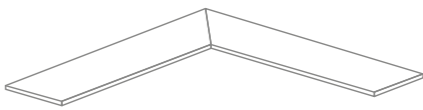
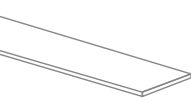
		
* Gradone bordo piscina □ Nat. Ret. 30x90 12"x35 1/2"	* Ang. Gradone bordo piscina - SX □ Nat. Ret. 30x90 12"x35 1/2"	* Ang. Gradone bordo piscina - DX □ Nat. Ret. 30x90 12"x35 1/2"
20 mm	20 mm	20 mm

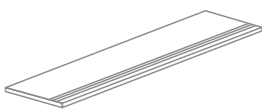
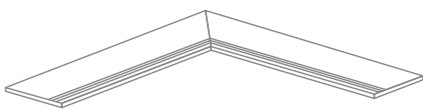
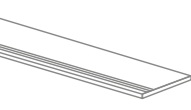
		
* Gradone grip bordo piscina □ Nat. Ret. 30x90 12"x35 1/2"	* Ang. Gradone grip bordo piscina - SX □ Nat. Ret. 30x90 12"x35 1/2"	* Ang. Gradone grip bordo piscina - DX □ Nat. Ret. 30x90 12"x35 1/2"
20 mm	20 mm	20 mm

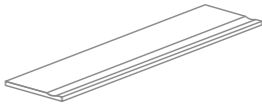
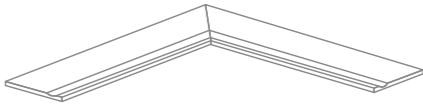
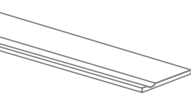
		
* Gradone svasato bordo piscina □ Nat. Ret. 30x90 12"x35 1/2"	* Ang. Gradone svasato bordo piscina - SX □ Nat. Ret. 30x90 12"x35 1/2"	* Ang. Gradone svasato bordo piscina - DX □ Nat. Ret. 30x90 12"x35 1/2"
20 mm	20 mm	20 mm

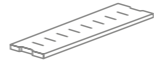
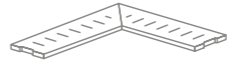
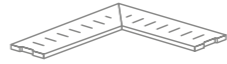
		
* Griglia □ Nat. Ret. 20x60 8"x24"	* Griglia SX □ Nat. Ret. 20x60 8"x24"	* Griglia DX □ Nat. Ret. 20x60 8"x24"
20 mm	20 mm	20 mm

Per maggiori informazioni su imballi e codici articolo potete consultare il nostro BOOK (anche da sito internet, nell'area "download").
For more information on packaging and item codes, please refer to our BOOK (also available for download on our website, in the "download" area).
Pour plus d'informations sur les emballages et les codes articles, vous pouvez consulter notre BOOK (également depuis le site, dans la zone "téléchargement").
Weitere Informationen zu Verpackungen und Artikelcodes finden Sie in unserem BOOK (auch auf der Website, im Bereich "Download").

PEZZI SPECIALI PER ESTERNO

Special pieces for outdoor
Pièces spéciales pour extérieur
Formteile für Aussenbereich

Elemento a L



Gradone grip



Gradone

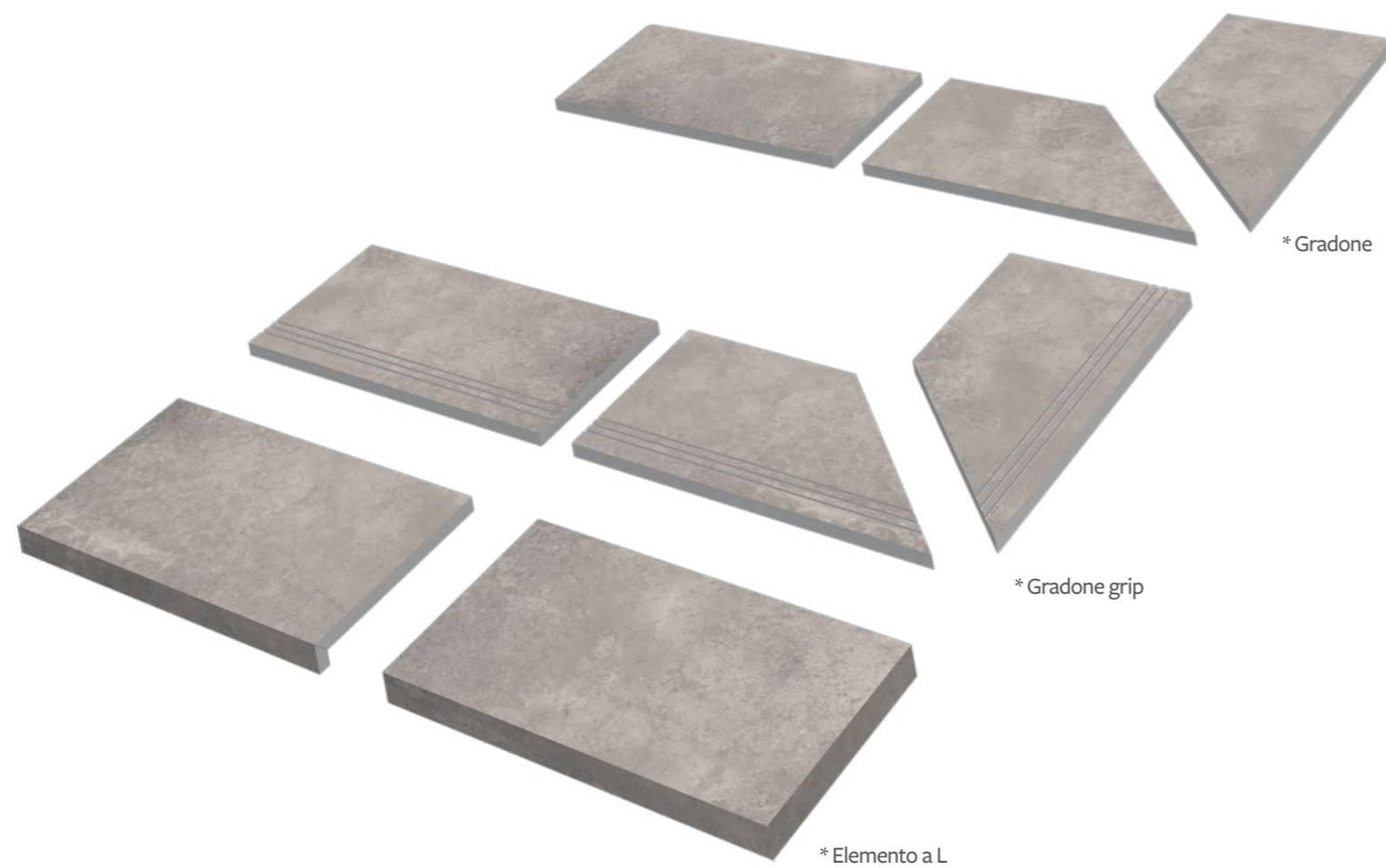
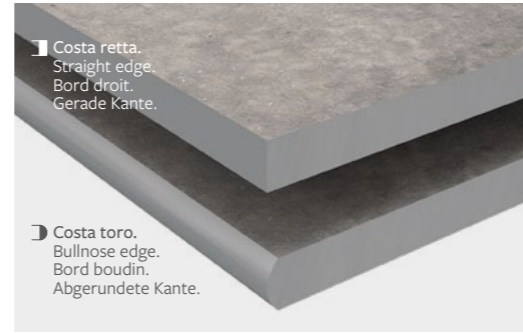

PEZZI SPECIALI PER PISCINA

Special pieces for swimming pool
Pièces spéciales pour piscine
Formteile für Schwimmbad

Gradone svasato bordo piscina

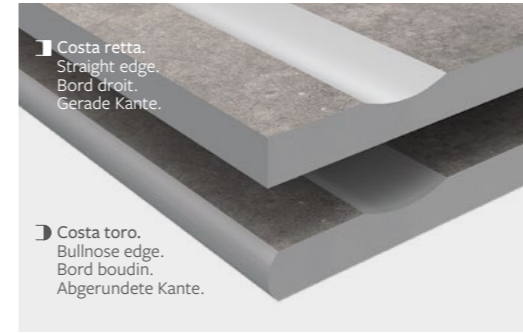

Gradone grip bordo piscina

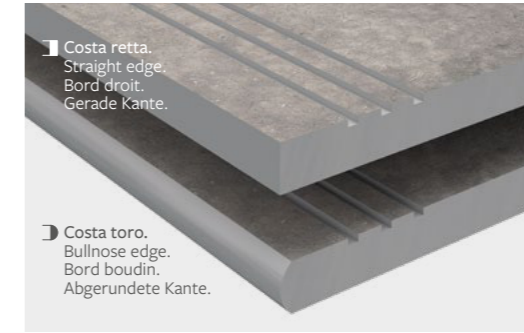

Gradone bordo piscina

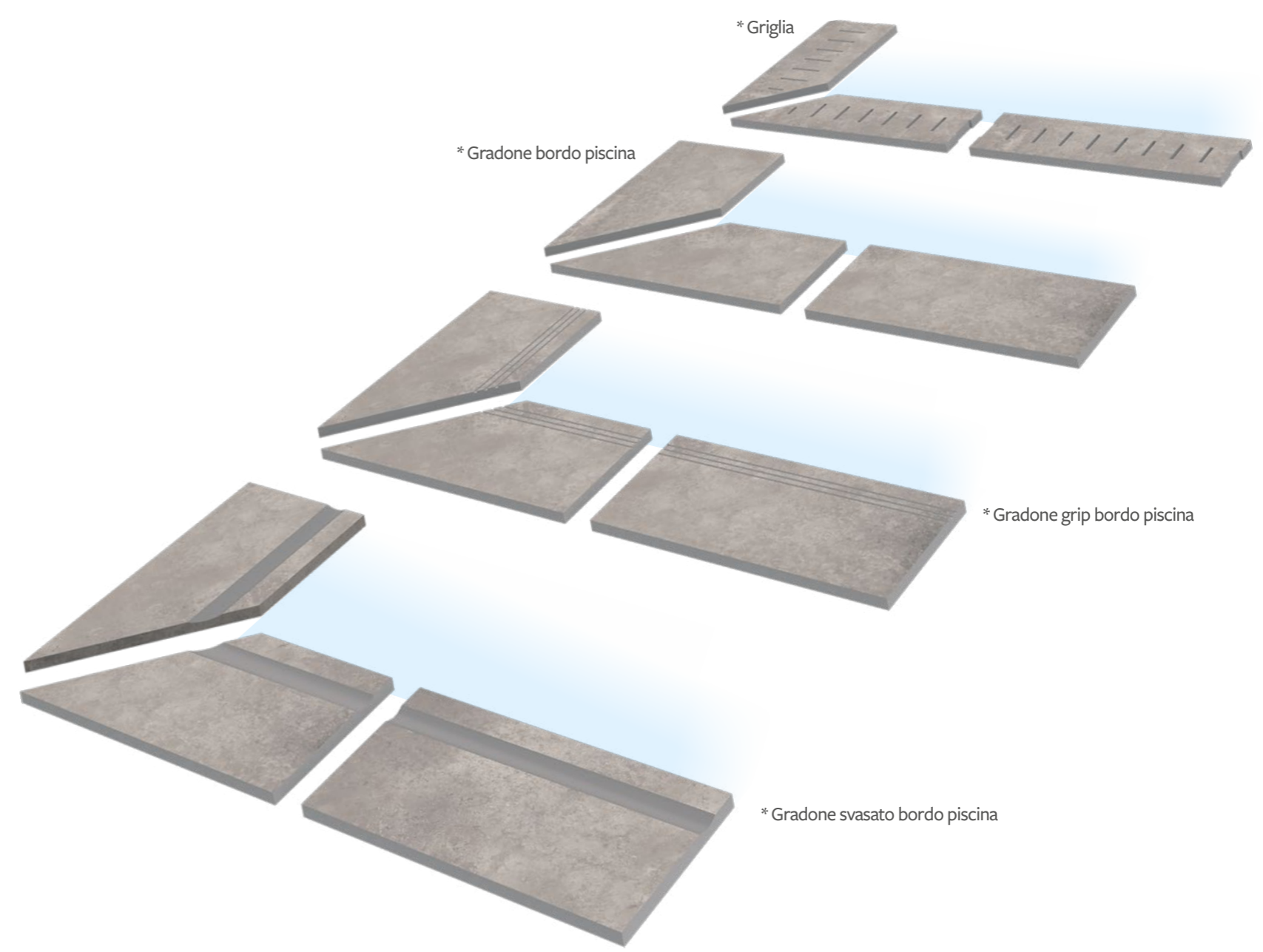
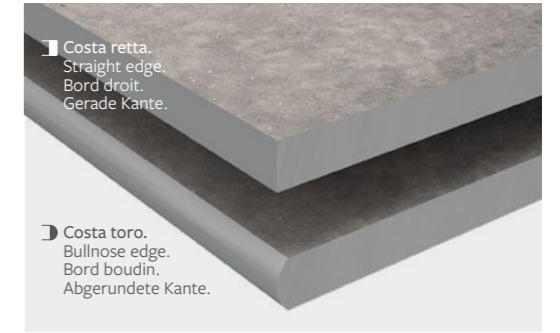

* I tempi di consegna di tutti i pezzi speciali mostrati in queste pagine sono di 30 giorni dalla data dell'ordine.
Delivery time for all the special pieces shown on these pages are generally 30 days from order date.
La livraison de toutes les pièces spéciales présentés dans les pages du catalogue sont disponible 30 jours à compter de la date de commande.
Der Liefertermin fuer die Spezialteile, die in dieser Seite aufgefuehrt sind, belaeuft sich auf 30 Tage nach Auftragsingang.

Pezzi speciali: massima cura in ogni dettaglio

Special pieces: the utmost care in every detail.
Pièces spéciales : le soin maximal dans le moindre détail.
Formteile: maximale Sorgfalt in jedem Detail.



Il fascino tradizionale del gradino a "C"

The traditional appeal of the "C" step.
Le charme traditionnel de l'étape « C ».
Der traditionelle Charme der „C“-Stufe.

Tagina pone attenzione a tutte le componenti architettoniche degli spazi da abitare. Ai gradini sono dedicati pezzi speciali appositamente progettati per ottenere il massimo risultato estetico. La gamma comprende un elemento "gradino a C" al quale si possono affiancare gli elementi che completano gli angoli sinistro e destro.

Tagina takes great care over all the architectural elements of the living spaces. Special pieces are used for the stairs, specially designed to obtain the maximum aesthetic result. The range includes a "C-step" element which can be combined with the elements that complete the left and right corners.

Tagina prête attention à toutes les composantes architecturales des espaces de vie. Les étapes sont dédiées à des pièces spéciales spécialement conçues pour obtenir un résultat esthétique maximal. La gamme comprend un élément « marche en C » auquel vous pouvez assortir les autres éléments qui complètent les angles gauche et droit.

Tagina achtet auf alle architektonischen Komponenten der Wohnräume. Den Stufen sind Spezialteile gewidmet, um ein optimales ästhetisches Ergebnis zu erzielen. Das Sortiment umfasst ein „C-Stufen-Element“, das durch Elemente zur Vervollständigung der linken und rechten Ecke ergänzt werden kann.

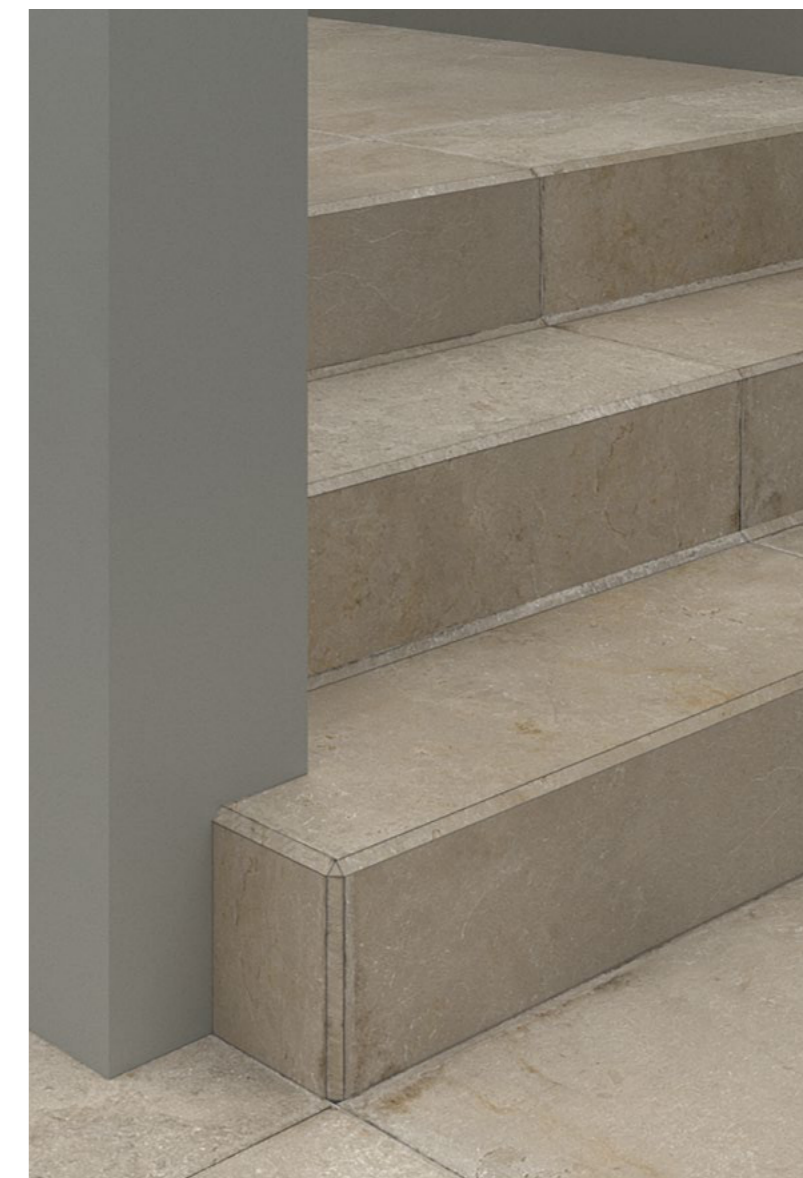
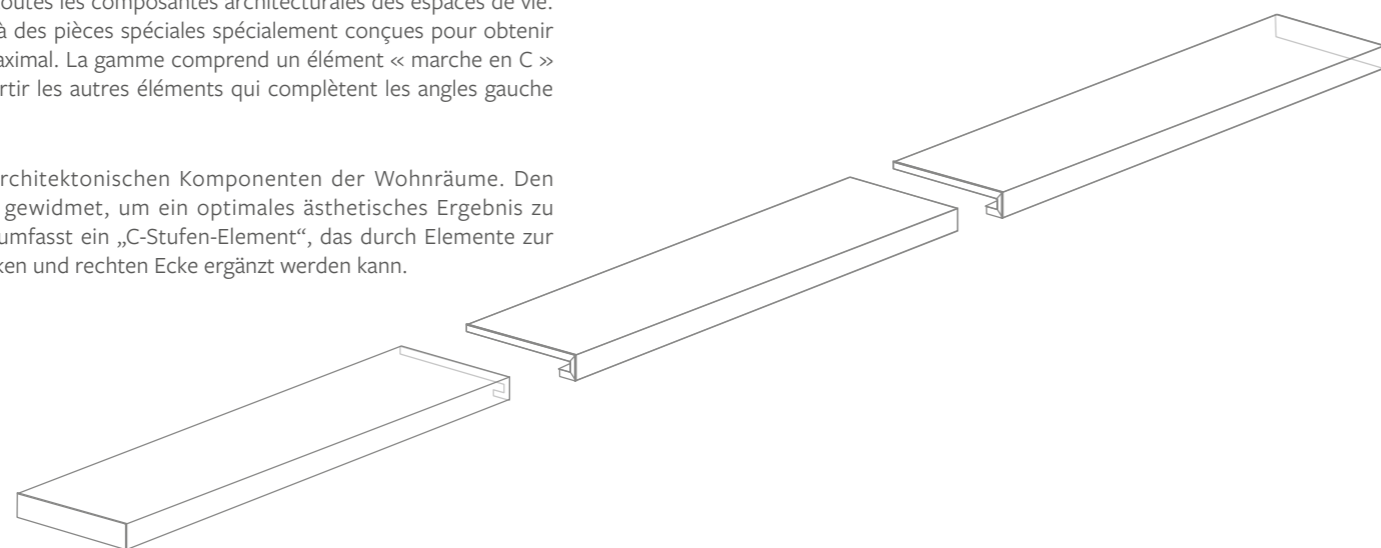

Il "coprispigo triangolare"

The "triangular edge cover".
Le « cache-arête triangulaire ».
„Dreieckiger Kantenschutz“.

La gamma Tagina include gli elementi "Coprispigo triangolare" e l'"Angolo Coprispigo triangolare". Essi consentono di risolvere con eleganza e semplicità problematiche legate alla congiunzione delle lastre in presenza di spigoli e angoli. È possibile adottare questa soluzione sia a rivestimento che a pavimento ad esempio per realizzare gradini o per comporre volumi geometrici.

The range of Tagina includes the "Triangular edge cover and triangular corner edge cover" elements. They allow problems encountered to be solved elegantly and simply when joining slabs where there are edges and corners. It is possible to adopt this solution both for cladding and flooring, e.g. to create steps or compose geometric volumes.

La gamme Tagina comprend les éléments « Cache-arête triangulaire et Angle Cache-arête Triangulaire ». Ils permettent de résoudre avec élégance et simplicité les problèmes liés à l'assemblage des dalles en présence de bords et de coins. Il est possible d'adopter cette solution aussi bien pour le revêtement que pour le dallage, par exemple pour créer des marches ou composer des volumes géométriques.

Das Sortiment Tagina umfasst das Element „Dreieckiger Kantenschutz und Dreieckige Eckabdeckung“. Beide Elemente ermöglichen, mit Eleganz und Einfachheit alle Probleme zu lösen, die mit dem Zusammenfügen der Platten bei Vorhandensein von Kanten und Ecken zusammenhängen. Diese Lösung kann sowohl für Verkleidungen als auch für Böden verwendet werden, beispielsweise um Stufen oder geometrische Volumen zu schaffen.



Suggerimenti per abbinare colori e stili Tagina

Tips for Matching Colours and Tagina Styles.
 Conseils pour faire correspondre les couleurs et les styles Tagina.
 Tipps für die Kombination von Tagina-Farben und -Stilen.



ERICE Nat. Ret.
 Modulo D4
 BANCONE . COUNTER Collection MARQUINA NERO 120x280 Lucidato Ret.

MARBLE & ONYX

CONCRETE & DESIGN

WOOD

DECORS

	DOR	BYBLOS	ERICE	MENFI
MEDITERRANEA SEGESTA	BLU CAMEL VERDE 	CAMEL VERDE 	BLU VERDE 	BLU CAMEL
MEDITERRANEA STATUARIO				
MEDITERRANEA PIETRA DI LUNA	BLANC ARGENT 	NOIR BEIGE 	BLEU GRIS 	BEIGE ARGENT
MEDITERRANEA FULL COLOURS	CLOUD MOON DESERT 	CLOUD SHADOW 	CLOUD MIDNIGHT 	CLOUD SHADOW
MEDITERRANEA METAL	CORTEN PEARL 	OXIDE CORTEN 	OXIDE 	CORTEN TITANIUM
MEDITERRANEA EVOQUE	DOUSSIE ROVERE BAHIA 	ROVERE KORINA 	BAHIA KORINA 	KORINA
MEDITERRANEA FOREST	FOREST 	FOREST 	FOREST 	FOREST
MEDITERRANEA JAY VINTAGE	ROSA ANTRACITE AVIO 	PEARL AZZURRO 	PEARL AVIO 	PEARL AZZURRO
Colore consigliato per la Fuga Recommended joint colour. Couleur d'échappement recommandée. Empfohlene Farbe für die Fuge.	RAL 9002 NCS 1502-Y	RAL 7044 NCS S 2005-G60Y	RAL 7035 NCS 2502-Y	RAL 7005 NCS 1010-Y20R



Tagina S.p.A.
Via Emilia Ponente, 925
48014 Castel Bolognese (RA) - Italy
Tel. +39 0545 197 7303

tagina.it -  DAFIN GROUP

