



**EXTRA**  
ORDINARY SIZE

M A R M I

## UNA GRANDE VERSATILITÀ PER OGNI CAMPO DI APPLICAZIONE

Great versatility in all fields of application  
 Une grande polyvalence pour tout domaine d'application  
 Eine grosse Vielseitigkeit für jeden Anwendungsbereich  
 Una gran versatilidad para cada campo de aplicación  
 Высокая универсальность в любой сфере применения  
 在任何应用场合广泛的适用性

Con i grandi formati si possono realizzare tagli di qualunque forma e dimensione, per ampliare ulteriormente le possibilità di utilizzo della lastra andando dal pavimento per arrivare al rivestimento di pareti, mobili, tavoli, piani, ante.

With large sizes, you can make cuts of any shape and size, to further extend the possibilities of use of the slab covering floors, walls, furniture, tables and doors.

Avec les grands formats on peut réaliser des coupes de toute forme et toute dimension, pour élargir ultérieurement la gamme d'utilisations de la plaque, en partant du revêtement de sol pour arriver au revêtement de parois, meubles, tables, plans et portes.

Mit Großformaten sind beliebig große Schnitte in unterschiedlichsten Formen möglich und die Anwendungsmöglichkeiten der Platte werden noch umfangreicher, von Böden bis hin zur Verkleidung von Wänden, Möbeln, Tischen, Flächen und Türen.

Con los grandes formatos se pueden realizar cortes de cualquier forma y dimensión para ampliar ulteriormente las posibilidades de uso de la losa, que abarca desde el pavimento hasta llegar al revestimiento de paredes, muebles, mesas, superficies y puertas.

Из больших форматов всегда можно создавать меньшие форматы любых форм и размеров, все более расширяя возможности применения плиты: от пола до облицовки стен, мебели, поверхностей, створок.

采用大规格的板材，可以随意切割成各种形状和尺寸的板材，进一步扩大板材的应用范围，可应用在地板、墙面装饰、家具、桌面、平台和窗板。

### WALL & FLOOR

#### PAVIMENTO E RIVESTIMENTO

Floor and covering. Revêtement sols et murs.  
 Boden und Verkleidungen. Pavimento y revestimiento.  
 Полы и облицовка. 地板及墙面。



MARMI / CREMA MARFIL

### FURNITURE AND DESIGN

#### TOP E RIVESTIMENTI COORDINATI

Coordinated top and covering. Top et revêtements coordonnés.  
 Tops und koordinierte Verkleidungen. Encimeras y revestimientos coordinados.  
 Комплекты столешниц и облицовок. 顶面及辅助装饰。



MARMI / CALACATTA

### FURNITURE AND DESIGN

#### ARREDAMENTO E DESIGN

Furnishings. Ameublement.  
 Einrichtung. Decoración.  
 Оформление помещений. 装修。



MARMI / CALACATTA

### FURNITURE AND DESIGN

#### PORTE E ANTE

Shutters and doors. Portes et battants.  
 Türen und Schranktüren. Puertas y hojas.  
 Двери и створки. 门和窗板。



MARMI / CALACATTA

### BUSINESS TO BUSINESS

#### PISCINE

Swimming pools. Piscines.  
 Schwimmbäder. Piscinas.  
 Бассейны. 泳池



MARMI / CALACATTA  
 CONTEMPORANEI / SKYLINE

### BUSINESS TO BUSINESS

#### CONTRACT

Контрактные поставки.  
 协议。



MARMI / CALACATTA

### BUSINESS TO BUSINESS

#### FACCIAE VENTILATE E INCOLLATE

Adhesive-mounted curtain walls. Façades ventilées et collées.  
 Hinterlüftete und verklebte Fassaden. Fachadas ventiladas y encoladas.  
 Вентилируемые и наклеенные фасады. 胶合通风外墙。

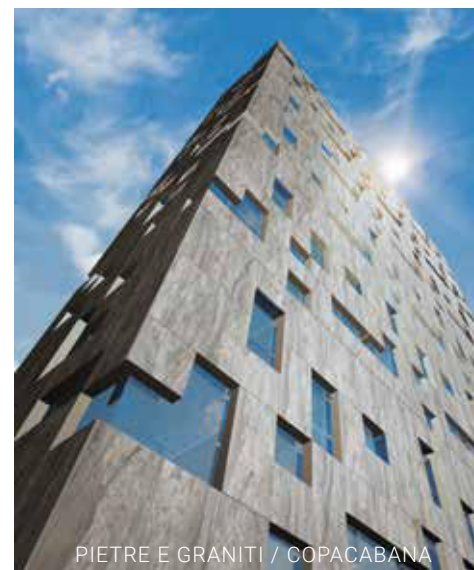

PIETRE E GRANITI / COPACABANA

### BUSINESS TO BUSINESS

#### INDUSTRIA NAVALE

Shipping industry. Industrie navale.  
 Schiffbauindustrie. Industria naval.  
 Кораблестроение. 船舶工业。



ONICI / AESTHETICA



MARMICALACATTA 160x320 - 63"x126" LAP. RET.



MARMICALACATTA 160x320 - 63"x126" LAP. RET.



CONTEMPORANEIDISTRICT TORTORA 160x320 - 63"x126" NAT. RET.



MARMICALACATTA 160x320 - 63"x126" LAP. RET.



**EXTRA**  
ORDINARY SIZE

SHADE  
SPECTRUM

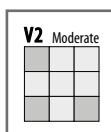
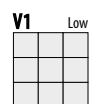

Spessore.

Thickness. Epaisseur. Stärke.  
Espesor. Толщина. 厚度.



100% DESIGN  
AND PRODUCTION  
OF ITALY

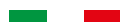

# MARMI

## BARDIGLIO CENERE

LASTRE IN GRES PORCELLANATO PRESSATE A SECCO

Dry-pressed porcelain stoneware slabs.

Dalles en grès cérame pressées à sec.

Trockengepresste Platten aus Feinsteinzeug.

Planchas en gres porcelánico prensadas en seco.

Керамогранитные плиты сухого прессования.

干压陶瓷砖.



**160x320cm.** 63"x126"  
thickness 6mm

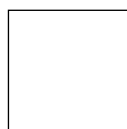

**160x160cm.** 63"x63"  
thickness 6mm



**80x160cm.** 31 1/2"x63"  
thickness 6mm



**80x80cm.** 31 1/2"x31 1/2"  
thickness 6mm



**80x240cm.** 31 1/2"x96"  
thickness 6mm

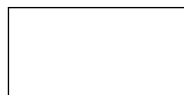

**120x240cm.** 48"x96"  
thickness 6mm



**120x120cm.** 48"x48"  
thickness 6mm



**60x120cm.** 24"x48"  
thickness 10mm



**60x60cm.** 24"x24"  
thickness 10mm

BARDIGLIO CENERE





**EXTRA**  
ORDINARY SIZE

SHADE  
SPECTRUM

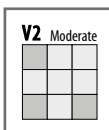
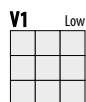

Spessore.

Thickness. Epaisseur. Stärke.  
Espesor. Толщина. 厚度.



100% DESIGN  
AND PRODUCTION  
OF ITALY



# MARMI LASA

LASTRE IN GRES PORCELLANATO PRESSATE A SECCO

Dry-pressed porcelain stoneware slabs.

Dalles en grès cérame pressées à sec.

Trockengepresste Platten aus Feinsteinzeug.

Planchas en gres porcelánico prensadas en seco.

Керамогранитные плиты сухого прессования.

干压陶瓷砖.



**160x320cm.** 63"x126"  
thickness 6mm



**160x160cm.** 63"x63"  
thickness 6mm



**80x160cm.** 31 1/2"x63"  
thickness 6mm



**80x80cm.** 31 1/2"x31 1/2"  
thickness 6mm



**120x240cm.** 48"x96"  
thickness 6mm



**120x120cm.** 48"x48"  
thickness 6mm



**60x120cm.** 24"x48"  
thickness 10mm



**60x60cm.** 24"x24"  
thickness 10mm



LASA

**EXTRA**  
ORDINARY SIZE

SHADE  
SPECTRUM

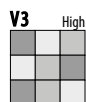
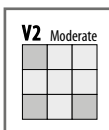
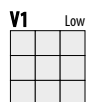

Spessore.

Thickness. Epaisseur. Stärke.  
Espesor. Толщина. 厚度.



100% DESIGN  
AND PRODUCTION  
OF ITALY



# MARMI

## AZUL MACAUBA

LASTRE IN GRES PORCELLANATO PRESSATE A SECCO

Dry-pressed porcelain stoneware slabs.

Dalles en grès cérame pressées à sec.

Trockengepresste Platten aus Feinsteinzeug.

Planchas en gres porcelánico prensadas en seco.

Керамогранитные плиты сухого прессования.

干压陶瓷砖.



**160x320cm.** 63"x126"  
thickness 6mm



**160x160cm.** 63"x63"  
thickness 6mm



**80x160cm.** 31 1/2"x63"  
thickness 6mm



**80x80cm.** 31 1/2"x31 1/2"  
thickness 6mm



**120x240cm.** 48"x96"  
thickness 6mm



**120x120cm.** 48"x48"  
thickness 6mm



**60x120cm.** 24"x48"  
thickness 10mm



**60x60cm.** 24"x24"  
thickness 10mm

AZUL MACAUBA



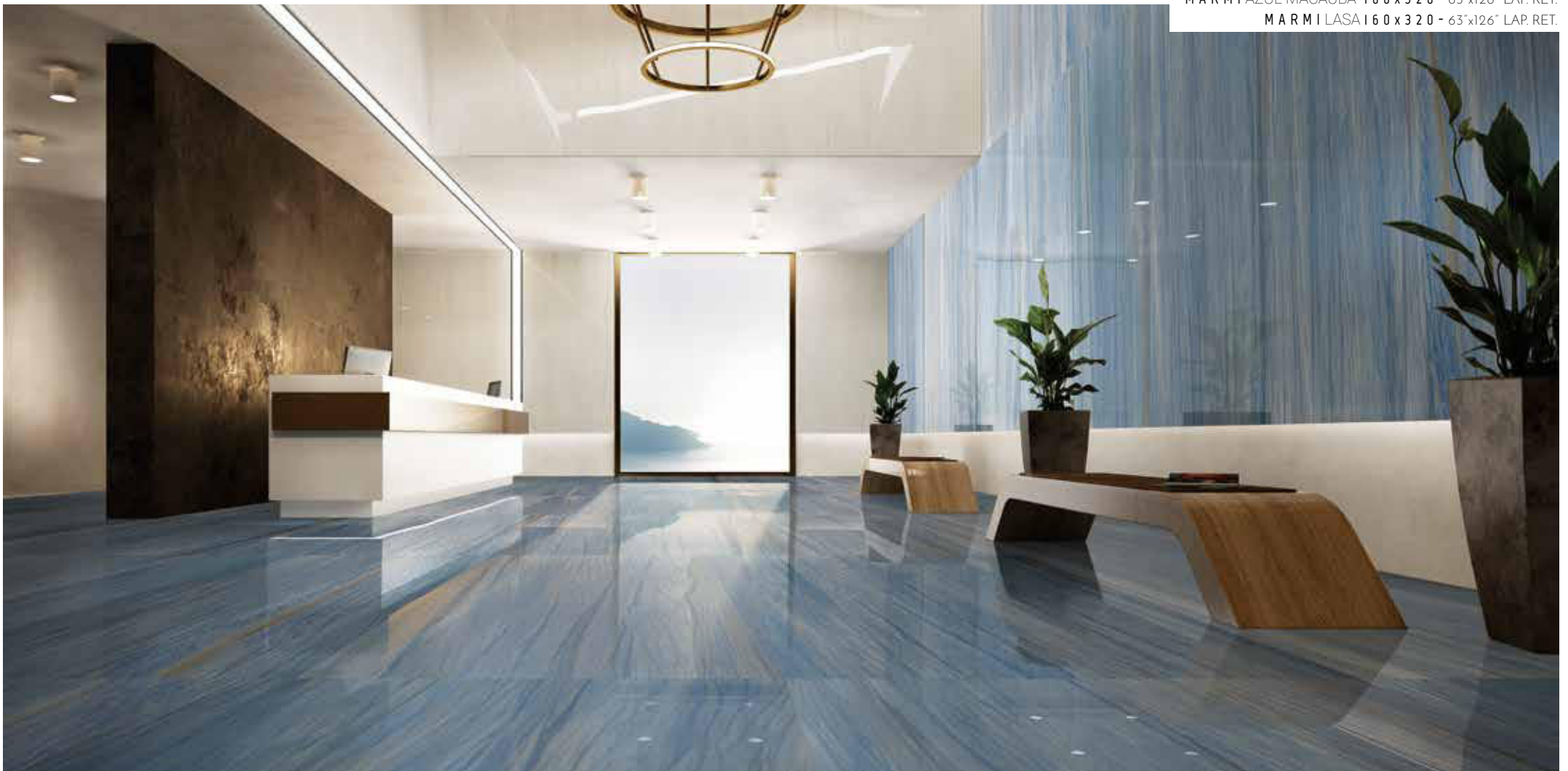



**EXTRA**  
ORDINARY SIZE

SHADE  
SPECTRUM

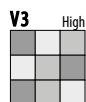
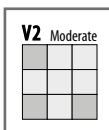
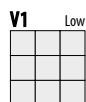

Spessore.

Thickness. Epaisseur. Stärke.  
Espesor. Толщина. 厚度.



100% DESIGN  
AND PRODUCTION  
OF ITALY

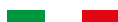

# MARMI

## NERO BELVEDERE

LASTRE IN GRES PORCELLANATO PRESSATE A SECCO

Dry-pressed porcelain stoneware slabs.

Dalles en grès cérame pressées à sec.

Trockengepresste Platten aus Feinsteinzeug.

Planchas en gres porcelánico prensadas en seco.

Керамогранитные плиты сухого прессования.

干压陶瓷砖.



**160x320cm.** 63"x126"  
thickness 6mm

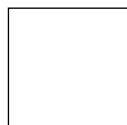

**160x160cm.** 63"x63"  
thickness 6mm



**80x160cm.** 31 1/2"x63"  
thickness 6mm



**80x80cm.** 31 1/2"x31 1/2"  
thickness 6mm



**120x240cm.** 48"x96"  
thickness 6mm



**120x120cm.** 48"x48"  
thickness 6mm



**60x120cm.** 24"x48"  
thickness 10mm



**60x60cm.** 24"x24"  
thickness 10mm

NERO BELVEDERE

**EXTRA**  
ORDINARY SIZE

SHADE  
SPECTRUM

V1 Low



V2 Moderate



V3 High



V4 Random



Spessore.

Thickness. Epaisseur. Stärke.  
Espesor. Толщина. 厚度.



100% DESIGN  
AND PRODUCTION  
OF ITALY



# MARMI STATUARIO SPLENDEnte

LASTRE IN GRES PORCELLANATO PRESSATE A SECCO

Dry-pressed porcelain stoneware slabs.

Dalles en grès cérame pressées à sec.

Trockengepresste Platten aus Feinsteinzeug.

Planchas en gres porcelánico prensadas en seco.

Керамогранитные плиты сухого прессования.

干压陶瓷砖.



**160x320cm.** 63"x126"  
thickness 6mm

**Slab A 160x320cm.** 63"x126"  
thickness 6mm

**Slab B 160x320cm.** 63"x126"  
thickness 6mm

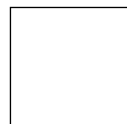

**160x160cm.** 63"x63"  
thickness 6mm

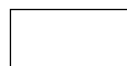

**80x160cm.** 31 1/2"x63"  
thickness 6mm



**80x80cm.** 31 1/2"x31 1/2"  
thickness 6mm



**80x240cm.** 31 1/2"x96"  
thickness 6mm



**120x240cm.** 48"x96"  
thickness 6mm

**Slab A 120x240cm.** 48"x96"  
thickness 6mm

**Slab B 120x240cm.** 48"x96"  
thickness 6mm



**120x120cm.** 48"x48"  
thickness 6mm



**60x120cm.** 24"x48"  
thickness 10mm



**60x60cm.** 24"x24"  
thickness 10mm



STATUARIO SPLENDEnte



# Slab A e B

Due grafiche identiche ma speculari per creare nuovi elementi decorativi.

## ESEMPI DI COMPOSIZIONI

Layout examples. Des exemples de compositions. Gestaltungsbeispiele. Ejemplos de composición. Примеры композиций. 地板及墙面。

Two identical graphics with a mirror image concept to create new decorative elements.  
Deux graphismes identiques mais spéculaires pour créer de nouveaux éléments décoratifs.  
Zwei identische, aber spiegelbildliche Graphiken, um neue Dekorelemente zu schaffen.  
Dos gráficas idénticas pero especulares para crear nuevos elementos decorativos.  
Два идентичных, но зеркально противоположных варианта графики для создания новых декоративных элементов.  
两块相同的镜面图案以产生新的装饰元素。

### 160x320 cm . 63"x126"

Esempio 1 / Example 1



Esempio 2 / Example 2



Esempio 3 / Example 3



Esempio 4 / Example 4

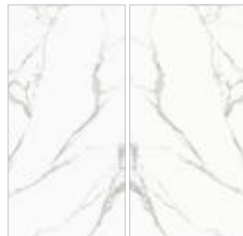

### 120x240 cm . 48"x96"

Esempio 1 / Example 1

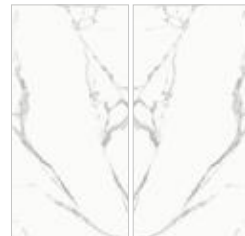

Esempio 2 / Example 2



Esempio 3 / Example 3

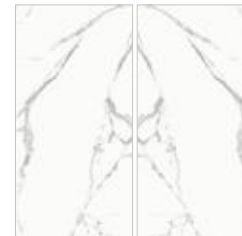

Esempio 4 / Example 4

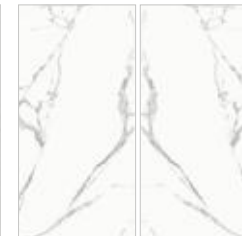

M A R M I STATUARIO SPLENDEnte 160 x 320 - 63"x126" LAP. RET.

M A R M I STATUARIO SPLENDEnte SLAB A - B 160 x 320 - 63"x126" LAP. RET.

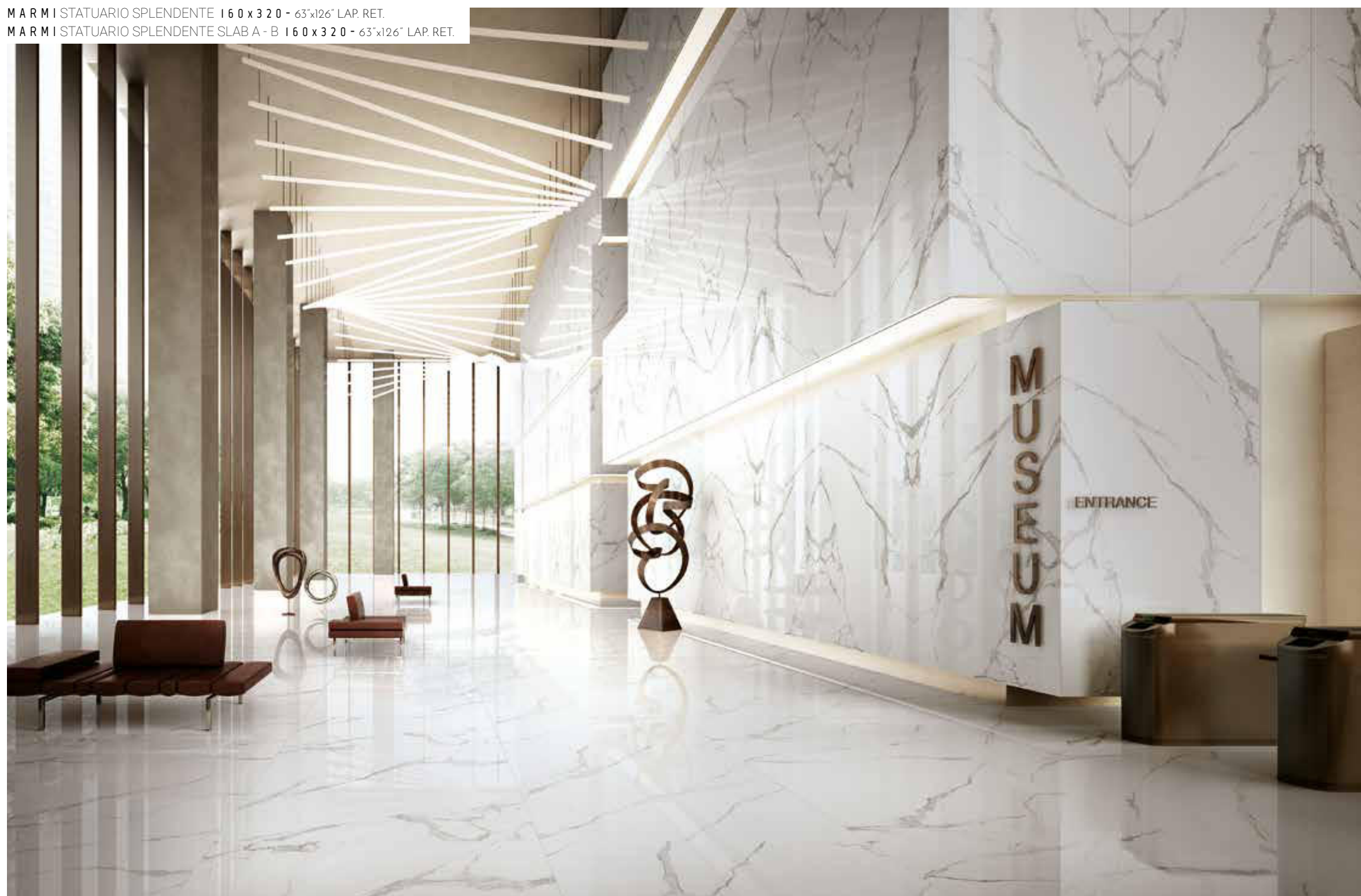

**EXTRA**  
ORDINARY SIZE

SHADE  
SPECTRUM

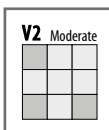
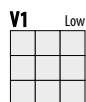

Spessore.

Thickness. Epaisseur. Stärke.  
Espesor. Толщина. 厚度.



100% DESIGN  
AND PRODUCTION  
OF ITALY



# MARMI STATUARIO

LASTRE IN GRES PORCELLANATO PRESSATE A SECCO

Dry-pressed porcelain stoneware slabs.

Dalles en grès cérame pressées à sec.

Trockengepresste Platten aus Feinsteinzeug.

Planchas en gres porcelánico prensadas en seco.

Керамогранитные плиты сухого прессования.

干压陶瓷砖.



**160x320cm.** 63"x126"  
thickness 6mm

**Slab A 160x320cm.** 63"x126"  
thickness 6mm

**Slab B 160x320cm.** 63"x126"  
thickness 6mm

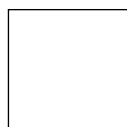

**160x160cm.** 63"x63"  
thickness 6mm



**80x160cm.** 31 1/2"x63"  
thickness 6mm



**80x80cm.** 31 1/2"x31 1/2"  
thickness 6mm



**120x240cm.** 48"x96"  
thickness 6mm

**Slab A 120x240cm.** 48"x96"  
thickness 6mm

**Slab B 120x240cm.** 48"x96"  
thickness 6mm



**120x120cm.** 48"x48"  
thickness 6mm



**60x120cm.** 24"x48"  
thickness 10mm



**60x60cm.** 24"x24"  
thickness 10mm



STATUARIO



# Slab A e B

Due grafiche identiche ma speculari per creare nuovi elementi decorativi.

## ESEMPI DI COMPOSIZIONI

Layout examples. Des exemples de compositions. Gestaltungsbeispiele. Ejemplos de composición. Примеры композиций. 地板及墙面。

Two identical graphics with a mirror image concept to create new decorative elements.  
Deux graphismes identiques mais spéculaires pour créer de nouveaux éléments décoratifs.  
Zwei identische, aber spiegelbildliche Graphiken, um neue Dekorelemente zu schaffen.  
Dos gráficas idénticas pero especulares para crear nuevos elementos decorativos.  
Два идентичных, но зеркально противоположных варианта графики для создания новых декоративных элементов.  
两块相同的镜面图案以产生新的装饰元素。

### 160x320 cm . 63"x126"

Esempio 1 / Example 1



Esempio 2 / Example 2



Esempio 3 / Example 3



Esempio 4 / Example 4



### 120x240 cm . 48"x96"

Esempio 1 / Example 1

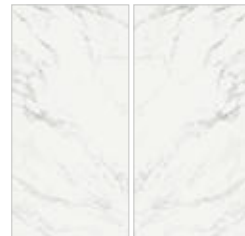

Esempio 2 / Example 2



Esempio 3 / Example 3



Esempio 4 / Example 4



MARMI STATUARIO SLAB A - B 160x320 - 63"x126" LAP. RET.

MARMI STATUARIO 160x320 - 63"x126" LAP. RET. / 160x160 - 63"x63" LAP. RET.



**EXTRA**  
ORDINARY SIZE

SHADE  
SPECTRUM

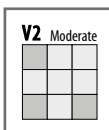
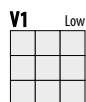

Spessore.

Thickness. Epaisseur. Stärke.  
Espesor. Толщина. 厚度.



100% DESIGN  
AND PRODUCTION  
OF ITALY



# MARMI CALACATTA

LASTRE IN GRES PORCELLANATO PRESSATE A SECCO

Dry-pressed porcelain stoneware slabs.

Dalles en grès cérame pressées à sec.

Trockengepresste Platten aus Feinsteinzeug.

Planchas en gres porcelánico prensadas en seco.

Керамогранитные плиты сухого прессования.

干压陶瓷砖.



**160x320cm.** 63"x126"  
thickness 6mm

**Slab A 160x320cm.** 63"x126"  
thickness 6mm

**Slab B 160x320cm.** 63"x126"  
thickness 6mm

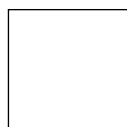

**160x160cm.** 63"x63"  
thickness 6mm



**80x160cm.** 31 1/2"x63"  
thickness 6mm



**80x80cm.** 31 1/2"x31 1/2"  
thickness 6mm



**120x240cm.** 48"x96"  
thickness 6mm

**Slab A 120x240cm.** 48"x96"  
thickness 6mm

**Slab B 120x240cm.** 48"x96"  
thickness 6mm



**120x120cm.** 48"x48"  
thickness 6mm



**60x120cm.** 24"x48"  
thickness 10mm



**60x60cm.** 24"x24"  
thickness 10mm



CALACATTA



# Slab A e B

Due grafiche identiche ma speculari per creare nuovi elementi decorativi.

## ESEMPI DI COMPOSIZIONI

Layout examples. Des exemples de compositions. Gestaltungsbeispiele. Ejemplos de composición. Примеры композиций. 地板及墙面。

Two identical graphics with a mirror image concept to create new decorative elements.  
Deux graphismes identiques mais spéculaires pour créer de nouveaux éléments décoratifs.  
Zwei identische, aber spiegelbildliche Graphiken, um neue Dekorelemente zu schaffen.  
Dos gráficas idénticas pero especulares para crear nuevos elementos decorativos.  
Два идентичных, но зеркально противоположных варианта графики для создания новых декоративных элементов.  
两块相同的镜面图案以产生新的装饰元素。

### 160x320 cm . 63"x126"

Esempio 1 / Example 1



Esempio 2 / Example 2



Esempio 3 / Example 3



Esempio 4 / Example 4



### 120x240 cm . 48"x96"

Esempio 1 / Example 1

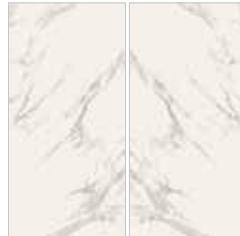

Esempio 2 / Example 2



Esempio 3 / Example 3



Esempio 4 / Example 4



MARMI CALACATTA SLAB A - B 160x320 - 63"x126" LAP. RET.

MARMI CALACATTA 160x320 - 63"x126" LAP. RET.

CONTEMPORANEI SKYLINE ANTRACITE 160x320 - 63"x126" NAT. RET.



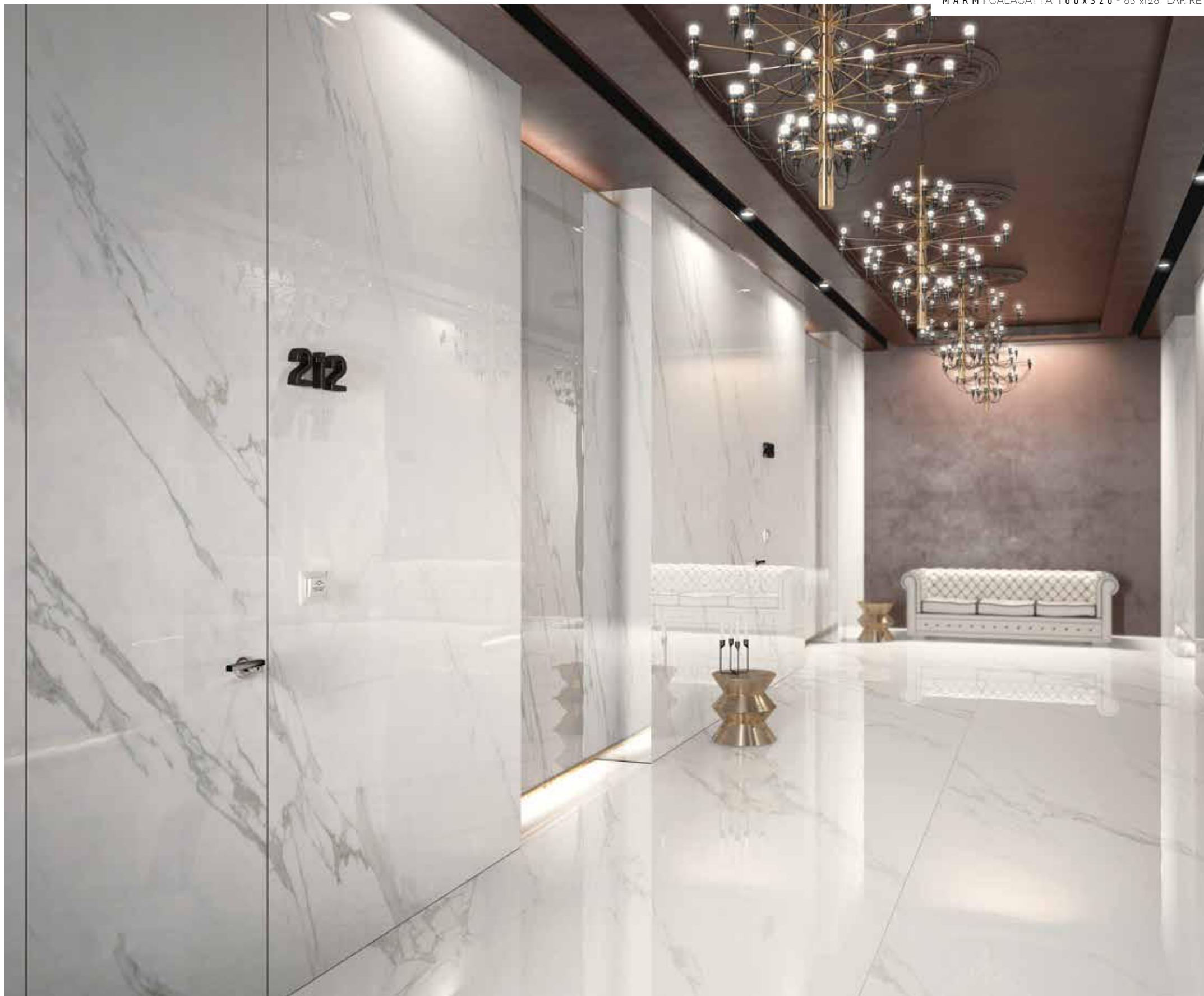

**EXTRA**  
ORDINARY SIZE

SHADE  
SPECTRUM

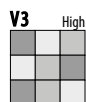
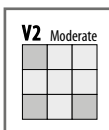
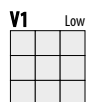

Spessore.

Thickness. Epaisseur. Stärke.  
Espesor. Толщина. 厚度.



100% DESIGN  
AND PRODUCTION  
OF ITALY



# MARMI CREMA MARFIL

LASTRE IN GRES PORCELLANATO PRESSATE A SECCO

Dry-pressed porcelain stoneware slabs.

Dalles en grès cérame pressées à sec.

Trockengepresste Platten aus Feinsteinzeug.

Planchas en gres porcelánico prensadas en seco.

Керамогранитные плиты сухого прессования.

干压陶瓷砖.



**160x320cm.** 63"x126"  
thickness 6mm

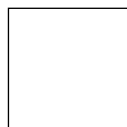

**160x160cm.** 63"x63"  
thickness 6mm



**80x160cm.** 31 1/2"x63"  
thickness 6mm



**80x80cm.** 31 1/2"x31 1/2"  
thickness 6mm

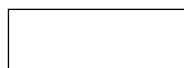

**80x240cm.** 31 1/2"x96"  
thickness 6mm



**120x240cm.** 48"x96"  
thickness 6mm



**120x120cm.** 48"x48"  
thickness 6mm



**60x120cm.** 24"x48"  
thickness 10mm



**60x60cm.** 24"x24"  
thickness 10mm

CREMA MARFIL





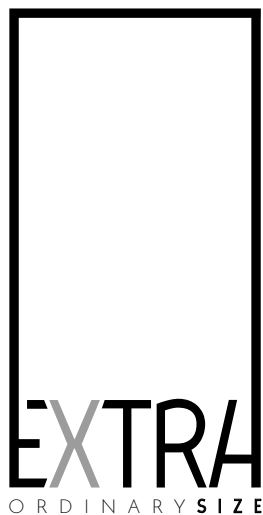

SHADE  
SPECTRUM

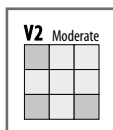
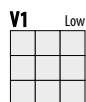

Spessore.

Thickness. Epaisseur. Stärke.  
Espesor. Толщина. 厚度.



100% DESIGN  
AND PRODUCTION  
OF ITALY



# MARMI

## BIANCO BERNINI

LASTRE IN GRES PORCELLANATO PRESSATE A SECCO

Dry-pressed porcelain stoneware slabs.

Dalles en grès cérame pressées à sec.

Trockengepresste Platten aus Feinsteinzeug.

Planchas en gres porcelánico prensadas en seco.

Керамогранитные плиты сухого прессования.

干压陶瓷砖.



**160x320cm.** 63"x126"  
thickness 6mm



**160x160cm.** 63"x63"  
thickness 6mm



**80x160cm.** 31 1/2"x63"  
thickness 6mm



**80x80cm.** 31 1/2"x31 1/2"  
thickness 6mm



**120x240cm.** 48"x96"  
thickness 6mm



**120x120cm.** 48"x48"  
thickness 6mm



**60x120cm.** 24"x48"  
thickness 10mm



**60x60cm.** 24"x24"  
thickness 10mm

BIANCO BERNINI

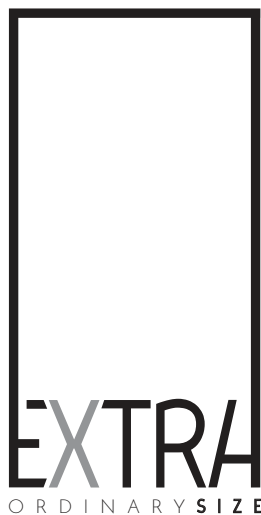

SHADE SPECTRUM

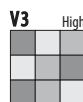
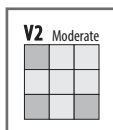

Spessore.

Thickness. Epaisseur. Stärke. Espesor. Толщина. 厚度.



100% DESIGN AND PRODUCTION OF ITALY



\*Articolo disponibile per progetti (ordine minimo circa 2.000mq).  
Article available for large-scale projects (minimum order: approximately 2,000 m<sup>2</sup>).  
Article disponible pour les projets (commande minimale environ 2000 m<sup>2</sup>).  
Für Projekte verfügbarer Artikel (Mindestbestellung ca. 2.000 qm.).  
Artículo disponible para proyectos (pedido mínimo aproximadamente 2.000 m<sup>2</sup>).  
Этот артикул поставляется для крупных проектов (минимальный заказ – около 2000 кв.м.).  
依项目而定的产品 (最小订单约2000平米)。

**Naturale e rettificato.**  
Natural and rectified.  
Naturel et rectifié.  
Natur Oberfläche und kalibriert.  
Natural y rectificado.  
Натуральный ректифицированный.  
天然和抛光。

**Lappato e rettificato.**  
Lappato and rectified.  
Lappato et rectifié.  
Lappato und kalibriert.  
Lappato y rectificado.  
Лаппатированный ректифицированный.  
亚光和抛光。

LASTRE IN GRES PORCELLANATO PRESSATE A SECCO

Dry-pressed porcelain stoneware slabs.  
Dalles en grès cérame pressées à sec.  
Trockengepresste Platten aus Feinsteinzeug.  
Planchas en gres porcelánico prensadas en seco.  
Керамогранитные плиты сухого прессования. 干压陶瓷砖。

UNI EN 14411-ISO 13006 appendice C gruppo BIa - UGL



BARDIGLIO CENERE



LASA

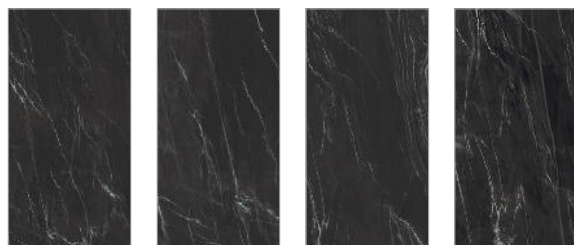

NERO BELVEDERE

Grande varietà nelle grafiche per un pavimento o rivestimento sempre vario a effetto "naturale". The collection is available in a wide variety of graphics for varied floor or wall solutions with a "natural" effect. Grande variété des graphiques pour un carrelage de sol ou un revêtement mural toujours différent et un effet "naturel". Große Vielfalt der Graphiken für einen ständig unterschiedlichen Boden- oder Wandbelag mit "natürlichem" Effekt. Gran variedad en las gráficas para un pavimento o revestimiento siempre diferente de efecto "natural". Предлагается большое разнообразие рисунков для укладки всегда меняющегося пола или облицовки с натуральным эффектом. 多样的图案让地板和涂层具有不同的“天然”色彩。

Spessore. Thickness. Epaisseur. Stärke. Espesor. Толщина. 厚度 6mm - 10mm

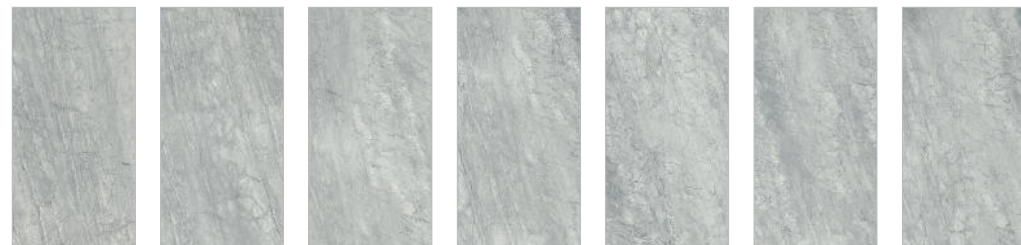

AZUL MACAUBA



		160x320 63"x126" 6 mm	120x240 48"x96" 6 mm	160x160 63"x63" 6 mm	120x120 48"x48" 6 mm	80x160 31 1/2"x63" 6 mm	80x240 31 1/2"x96" 6 mm	80x80 31 1/2"x31 1/2" 6 mm	60x120 24"x48" 10 mm	60x60 24"x24" 10 mm
Bardiglio Cenere	<input type="radio"/> Lap. Ret. 6 mm	087005	087025	087045	087065	087085	087533	087105	-	-
	<input type="checkbox"/> Nat. Ret. 6 mm	087006	087026	087046	087066	087086	-	087106	-	-
	<input type="radio"/> Lap. Ret. 10 mm	-	-	-	-	-	-	-	087125	087145
	<input type="checkbox"/> Nat. Ret. 10 mm	-	-	-	-	-	-	-	087126	087146
Lasa	<input type="radio"/> Lap. Ret. 6 mm	087003	087023	087043	087063	087083	-	087103	-	-
	<input type="checkbox"/> Nat. Ret. 6 mm	087004	087024	087044	087064	087084	-	087104	-	-
	<input type="radio"/> Lap. Ret. 10 mm	-	-	-	-	-	-	-	087123	087143
	<input type="checkbox"/> Nat. Ret. 10 mm	-	-	-	-	-	-	-	087124	087144
Azul Macauba	<input type="radio"/> Lap. Ret. 6 mm	087001	087021	087041	087061	087081	-	087101	-	-
	<input type="checkbox"/> Nat. Ret. 6 mm	087002	087022	087042	087062	087082	-	087102	-	-
	<input type="radio"/> Lap. Ret. 10 mm	-	-	-	-	-	-	-	087121	087141
	<input type="checkbox"/> Nat. Ret. 10 mm	-	-	-	-	-	-	-	087122 <small>*(min. 2.000 mq)</small>	087142 <small>*(min. 2.000 mq)</small>
Nero Belvedere	<input type="radio"/> Lap. Ret. 6 mm	087013	087033	087049	087069	087089	-	087109	-	-
	<input type="radio"/> Lap. Ret. 10 mm	-	-	-	-	-	-	-	087129	087149



# EXTRA

ORDINARY SIZE

## SHADE SPECTRUM

V1 Low



V2 Moderate



V3 High



V4 Random



## Spessore.

Thickness. Epaisseur. Stärke. Espesor. Толщина. 厚度.



100% DESIGN AND PRODUCTION OF ITALY



\*Articolo disponibile per progetti (ordine minimo circa 2.000mq).

Article available for large-scale projects (minimum order: approximately 2,000 m<sup>2</sup>).  
 Article disponible pour les projets (commande minimale environ 2000 m<sup>2</sup>).  
 Für Projekte verfügbarer Artikel (Mindestbestellung ca. 2.000 qm.).  
 Artículo disponible para proyectos (pedido mínimo aproximadamente 2.000 m<sup>2</sup>).  
 Этот артикул поставляется для крупных проектов (минимальный заказ – около 2000 кв.м.).  
 依项目而定的产品 (最小订单约2000平米)。

○ Naturale e rettificato.

Natural and rectified.

Naturel et rectifié.

Natur Oberfläche und kalibriert.

Natural y rectificado.

Натуральный ректифицированный.

天然和拋光。

○ Lappato e rettificato.

Lappato and rectified.

Lappato et rectifié.

Lappato und kalibriert.

Lappato y rectificado.

Лаппатированный ректифицированный.

亚光和拋光。

## LASTRE IN GRES PORCELLANATO PRESSATE A SECCO

Dry-pressed porcelain stoneware slabs.

Dalles en grès cérame pressées à sec.

Trockengepresste Platten aus Feinsteinzeug.

Planchas en gres porcelánico prensadas en seco.

Керамогранитные плиты сухого прессования. 干压陶瓷砖。

UNI EN 14411-ISO 13006 appendice C gruppo Bla - UGL

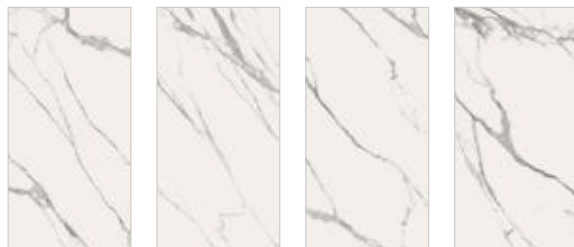

STATUARIO SPLENDENTE

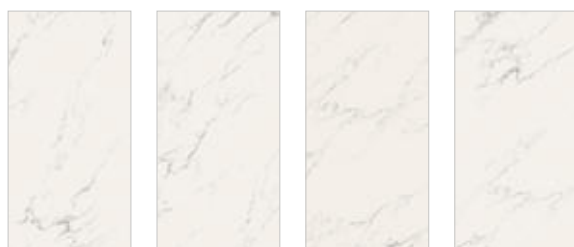

STATUARIO

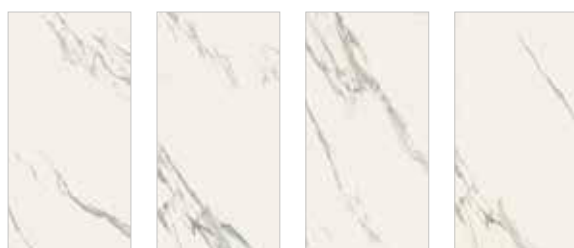

CALACATTA

Grande varietà nelle grafiche per un pavimento o rivestimento sempre vario a effetto "naturale". The collection is available in a wide variety of graphics for varied floor or wall solutions with a "natural" effect. Grande variété des graphiques pour un carrelage de sol ou un revêtement mural toujours différent et un effet "naturel". Große Vielfalt der Graphiken für einen ständig unterschiedlichen Boden- oder Wandbelag mit "natürlichem" Effekt. Gran variedad en las gráficas para un pavimento o revestimiento siempre diferente de efecto "natural". Предлагается большое разнообразие рисунков для укладки всегда меняющегося пола или облицовки с натуральным эффектом. 多样的图案让地板和涂层具有不同的“天然”色彩。

Spessore. Thickness. Epaisseur. Stärke. Espesor. Толщина. 厚度 6mm - 10mm

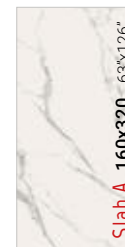
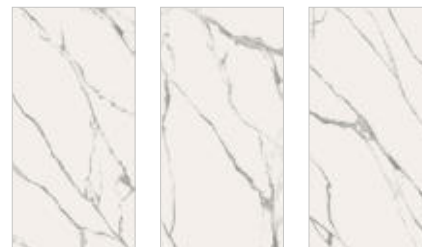

STATUARIO SPLENDENTE Slab A

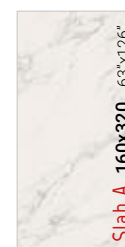

STATUARIO Slab A



STATUARIO SPLENDENTE Slab B

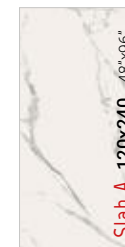

STATUARIO SPLENDENTE Slab A



STATUARIO SPLENDENTE Slab B

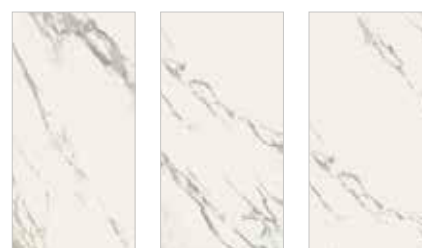

CALACATTA Slab A

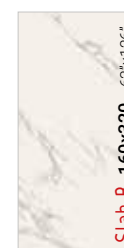
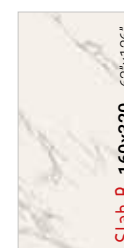

CALACATTA Slab B

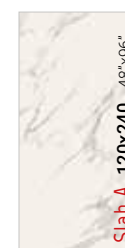

CALACATTA Slab A



CALACATTA Slab B



160x320  
63"x126"  
6 mm



120x240  
48"x96"  
6 mm



160x160  
63"x63"  
6 mm



120x120  
48"x48"  
6 mm



80x160  
31 1/2"x63"  
6 mm



80x240  
31 1/2"x96"  
6 mm



80x80  
31 1/2"x31 1/2"  
6 mm



60x120  
24"x48"  
10 mm



60x60  
24"x24"  
10 mm

Statuario Splendente	○ Lap. Ret. 6 mm	087007	087027	087047	087067	087087	087532	087107	-	-
	□ Nat. Ret. 6 mm	087008	087028	087048	087068	087088	-	087108	-	-
Slab A	○ Lap. Ret. 10 mm	-	-	-	-	-	-	-	087127	087147
	□ Nat. Ret. 10 mm	-	-	-	-	-	-	-	087128	087148
Slab B	○ Lap. Ret. 6 mm	087011	087031	-	-	-	-	-	-	-
Statuario	○ Lap. Ret. 6 mm	083003	083013	083023	083033	083043	-	083053	-	-
	□ Nat. Ret. 6 mm	083004	083014	083024	083034	083044	-	083054	-	-
Slab A	○ Lap. Ret. 10 mm	-	-	-	-	-	-	-	083063	083083
	□ Nat. Ret. 10 mm	-	-	-	-	-	-	-	083064	083084
Slab B	○ Lap. Ret. 6 mm	083091	083110	-	-	-	-	-	-	-
Calacatta	○ Lap. Ret. 6 mm	083092	083111	-	-	-	-	-	-	-
	○ Lap. Ret. 6 mm	083005	083015	083025	083035	083045	-	083055	-	-
Slab A	□ Nat. Ret. 6 mm	083006	083016	083026	083036	083046	-	083056	-	-
	○ Lap. Ret. 10 mm	-	-	-	-	-	-	-	083065	083085
Slab B	□ Nat. Ret. 10 mm	-	-	-	-	-	-	-	083066	083086
	○ Lap. Ret. 6 mm	083093	083112	-	-	-	-	-	-	-
Slab B	○ Lap. Ret. 6 mm	083094	083113	-	-	-	-	-	-	-

# EXTRA

ORDINARY SIZE

## SHADE SPECTRUM

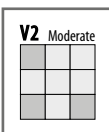
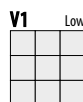

## Spessore.

Thickness. Epaisseur. Stärke. Espesor. Толщина. 厚度.



100% DESIGN AND PRODUCTION OF ITALY



\*Articolo disponibile per progetti (ordine minimo circa 2.000mq).

Article available for large-scale projects (minimum order: approximately 2,000 m<sup>2</sup>).

Article disponible pour les projets (commande minimale environ 2000 m<sup>2</sup>).

Für Projekte verfügbarer Artikel (Mindestbestellung ca. 2.000 qm.).

Artículo disponible para proyectos (pedido mínimo aproximadamente 2.000 m<sup>2</sup>).

Этот артикул поставляется для крупных проектов

(минимальный заказ – около 2000 кв.м.).

依项目而定的产品 (最小订单约2000平米)。

□ **Naturale e rettificato.**

Natural and rectified.

Naturel et rectifié.

Natur Oberfläche und kalibriert.

Natural y rectificado.

Натуральный ректифицированный.

天然和抛光。

○ **Lappato e rettificato.**

Lappato and rectified.

Lappato et rectifié.

Lappato und kalibriert.

Lappato y rectificado.

Лаппатированный ректифицированный.

亚光和抛光。

## LASTRE IN GRES PORCELLANATO PRESSATE A SECCO

Dry-pressed porcelain stoneware slabs.

Dalles en grès cérame pressées à sec.

Trockengepresste Platten aus Feinsteinzeug.

Planchas en gres porcelánico prensadas en seco.

Керамогранитные плиты сухого прессования. 干压陶瓷砖。

UNI EN 14411-ISO 13006 appendice C gruppo Bla - UGL



CREMA MARFIL



BIANCO BERNINI

Grande varietà nelle grafiche per un pavimento o rivestimento sempre vario a effetto "naturale". The collection is available in a wide variety of graphics for varied floor or wall solutions with a "natural" effect. Grande variété des graphiques pour un carrelage de sol ou un revêtement mural toujours différent et un effet "naturel". Große Vielfalt der Graphiken für einen ständig unterschiedlichen Boden- oder Wandbelag mit "natürlichem" Effekt. Gran variedad en las gráficas para un pavimento o revestimiento siempre diferente de efecto "natural". Предлагается большое разнообразие рисунков для укладки всегда меняющегося пола или облицовки с натуральным эффектом. 多样的图案让地板和涂层具有不同的“天然”色彩。

Spessore. Thickness. Epaisseur. Stärke. Espesor. Толщина. 厚度 6mm - 10mm



		<b>160x320</b> 63"x126"	<b>120x240</b> 48"x96"	<b>160x160</b> 63"x63"	<b>120x120</b> 48"x48"	<b>80x160</b> 31 1/2"x63"	<b>80x240</b> 31 1/2"x96"	<b>80x80</b> 31 1/2"x31 1/2"	<b>60x120</b> 24"x48"	<b>60x60</b> 24"x24"
		<b>6 mm</b>	<b>6 mm</b>	<b>6 mm</b>	<b>6 mm</b>	<b>6 mm</b>	<b>6 mm</b>	<b>6 mm</b>	<b>10 mm</b>	<b>10 mm</b>
Crema Marfil	○ Lap. Ret. <b>6 mm</b>	<b>083009</b>	<b>083019</b>	<b>083029</b>	<b>083039</b>	<b>083049</b>	<b>083557</b>	<b>083059</b>	-	-
	□ Nat. Ret. <b>6 mm</b>	<b>083010</b>	<b>083020</b>	<b>083030</b>	<b>083040</b>	<b>083050</b>	-	<b>083060</b>	-	-
	○ Lap. Ret. <b>10 mm</b>	-	-	-	-	-	-	-	<b>083069</b>	<b>083087</b> <i>*(min. 2.000 mq)</i>
	□ Nat. Ret. <b>10 mm</b>	-	-	-	-	-	-	-	<b>083070</b>	<b>083088</b> <i>*(min. 2.000 mq)</i>
Bianco Bernini	○ Lap. Ret. <b>6 mm</b>	<b>083001</b>	<b>083011</b>	<b>083021</b>	<b>083031</b>	<b>083041</b>	-	<b>083051</b>	-	-
	□ Nat. Ret. <b>6 mm</b>	<b>083002</b>	<b>083012</b>	<b>083022</b>	<b>083032</b>	<b>083042</b>	-	<b>083052</b>	-	-
	○ Lap. Ret. <b>10 mm</b>	-	-	-	-	-	-	-	<b>083061</b>	<b>083081</b> <i>*(min. 2.000 mq)</i>
	□ Nat. Ret. <b>10 mm</b>	-	-	-	-	-	-	-	<b>083062</b> <i>*(min. 2.000 mq)</i>	<b>083082</b> <i>*(min. 2.000 mq)</i>

## DECORI

Decors . Décors . Dekore . Decoraciones . Декоры . 飾

### Mosaico

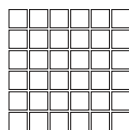

**30x30cm.** 12"x12" Lap. Ret.  
thickness 6mm

## \* PEZZI SPECIALI

Trims . Pièces spéciales . Formstücke . Piezas especiales . Специальные элементы . 特别部件

### COSTA RETTA: Straight nose:

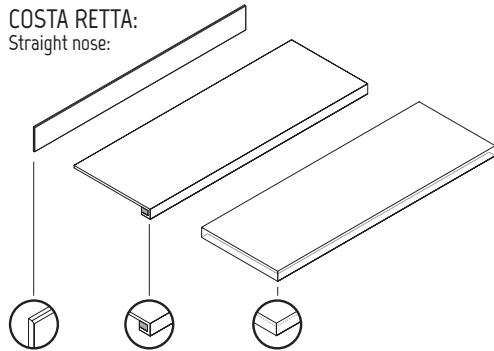

Scuretto  
Rabbeted  
riser

Gradino  
costa retta  
Straight  
nosed stair

Gradino  
costa retta angolo  
Straight nosed  
corner step

### BORDO DRITTO: Straight edge:

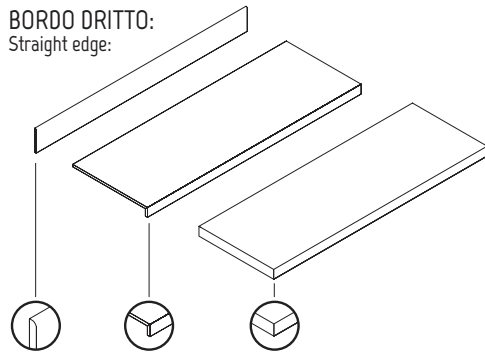

Battiscopa  
Skirting

Gradino  
bordo dritto  
Straight-edge  
step

Gradino  
bordo dritto angolo  
Straight-edge  
corner step

\*

### A disposizione solo su richiesta. Tempi di consegna: 30gg.

Available upon request only. Delivery terms: 30 days.  
Disponibile seulement sur requête. Délais de livraison: 30 jours.  
Verfügbar auf Anfrage. Lieferzeit: 30 Tage.  
Disponibile sólo bajo pedido. Plazo de entrega: 30 días.  
Изготавливается только по специальной заявке.  
Срок поставки: 30 дней.  
仅依订购。交货时间: 30日。

### Per il gradino non si garantisce la stessa tonalità del fondo.

We cannot guarantee that the shade of the stair tile will be the same as the background tile.  
Pour la marche, nous ne garantissons pas la même tonalité du fond.  
Für die Stufe wird nicht der gleiche Farbton des Untergrunds garantiert.  
Para el peldaño no se garantiza el mismo tono del fondo.  
Для ступени не гарантирована одинаковость тона с фоном.  
对于台阶不保证底色一致。

		Battiscopa Skirting 120x6,5 48"x2 1/2"	Battiscopa Skirting 80x8 31 1/2"x3"	Scuretto Rabbeted riser 160x20 63"x8"	Scuretto Rabbeted riser 120x20 48"x8"	Scuretto Rabbeted riser 80x20 31 1/2"x8"
Bianco Bernini	○ Lap. Ret. 10 mm	✓	-	-	✓	-
	□ Nat. Ret. 10 mm	-	-	-	-	-
	○ Lap. Ret. 6 mm	-	✓	✓	-	✓
	□ Nat. Ret. 6 mm	-	✓	✓	-	✓
Calacatta	○ Lap. Ret. 10 mm	✓	-	-	✓	-
	□ Nat. Ret. 10 mm	✓	-	-	✓	-
	○ Lap. Ret. 6 mm	-	✓	✓	-	✓
	□ Nat. Ret. 6 mm	-	✓	✓	-	✓
Crema Marfil	○ Lap. Ret. 10 mm	✓	-	-	✓	-
	□ Nat. Ret. 10 mm	✓	-	-	✓	-
	○ Lap. Ret. 6 mm	-	✓	✓	-	✓
	□ Nat. Ret. 6 mm	-	✓	✓	-	✓
Statuario	○ Lap. Ret. 10 mm	✓	-	-	✓	-
	□ Nat. Ret. 10 mm	✓	-	-	✓	-
	○ Lap. Ret. 6 mm	-	✓	✓	-	✓
	□ Nat. Ret. 6 mm	-	✓	✓	-	✓
Bardiglio Cenere	○ Lap. Ret. 10 mm	✓	-	-	✓	-
	□ Nat. Ret. 10 mm	✓	-	-	✓	-
	○ Lap. Ret. 6 mm	-	✓	✓	-	✓
	□ Nat. Ret. 6 mm	-	✓	✓	-	✓
Lasa	○ Lap. Ret. 10 mm	✓	-	-	✓	-
	□ Nat. Ret. 10 mm	✓	-	-	✓	-
	○ Lap. Ret. 6 mm	-	✓	✓	-	✓
	□ Nat. Ret. 6 mm	-	✓	✓	-	✓
Azul Macauba	○ Lap. Ret. 10 mm	✓	-	-	✓	-
	□ Nat. Ret. 10 mm	-	-	-	-	-
	○ Lap. Ret. 6 mm	-	✓	✓	-	✓
	□ Nat. Ret. 6 mm	-	✓	✓	-	✓
Statuario Splendente	○ Lap. Ret. 10 mm	✓	-	-	✓	-
	□ Nat. Ret. 10 mm	✓	-	-	✓	-
	○ Lap. Ret. 6 mm	-	✓	✓	-	✓
	□ Nat. Ret. 6 mm	-	✓	✓	-	✓
Nero Belvedere	○ Lap. Ret. 10 mm	✓	-	-	✓	-
	○ Lap. Ret. 6 mm	-	✓	✓	-	✓

○ **Lappato e rettificato.** Lappato and rectified. Lappato et rectifié. Lappato und kalibriert. Lappato y rectificado.  
Лаппатированный ректифицированный. 亚光和抛光。

□ **Naturale e rettificato.** Natural and rectified. Naturel et rectifié. Natur Oberfläche und kalibriert. Natural y rectificado.  
Натуральный ректифицированный. 天然和抛光。



		GRADINO COSTA RETTA - STRAIGHT NOSED STAIR					
		160x33x3,2 h 63°x13°x1 1/4°h	160x33x3,2 h 63°x13°x1 1/4°h Angolo dx-sx	120x33x3,2 h 48°x13°x1 1/4°h	120x33x3,2 h 48°x13°x1 1/4°h Angolo dx-sx	80x33x3,2 h 31 1/2°x13°x1 1/4°h	80x33x3,2 h 31 1/2°x13°x1 1/4°h Angolo dx-sx
Bianco Bernini	○ Lap. Ret. 10 mm	-	-	✓	✓	-	-
	□ Nat. Ret. 10 mm	-	-	-	-	-	-
	○ Lap. Ret. 6 mm	✓	✓	✓	✓	✓	✓
	□ Nat. Ret. 6 mm	✓	✓	✓	✓	✓	✓
Calacatta	○ Lap. Ret. 10 mm	-	-	✓	✓	-	-
	□ Nat. Ret. 10 mm	-	-	✓	✓	-	-
	○ Lap. Ret. 6 mm	✓	✓	✓	✓	✓	✓
	□ Nat. Ret. 6 mm	✓	✓	✓	✓	✓	✓
Crema Marfil	○ Lap. Ret. 10 mm	-	-	✓	✓	-	-
	□ Nat. Ret. 10 mm	-	-	✓	✓	-	-
	○ Lap. Ret. 6 mm	✓	✓	✓	✓	✓	✓
	□ Nat. Ret. 6 mm	✓	✓	✓	✓	✓	✓
Statuario	○ Lap. Ret. 10 mm	-	-	✓	✓	-	-
	□ Nat. Ret. 10 mm	-	-	✓	✓	-	-
	○ Lap. Ret. 6 mm	✓	✓	✓	✓	✓	✓
	□ Nat. Ret. 6 mm	✓	✓	✓	✓	✓	✓
Bardiglio Cenere	○ Lap. Ret. 10 mm	-	-	✓	✓	-	-
	□ Nat. Ret. 10 mm	-	-	✓	✓	-	-
	○ Lap. Ret. 6 mm	✓	✓	✓	✓	✓	✓
	□ Nat. Ret. 6 mm	✓	✓	✓	✓	✓	✓
Lasa	○ Lap. Ret. 10 mm	-	-	✓	✓	-	-
	□ Nat. Ret. 10 mm	-	-	✓	✓	-	-
	○ Lap. Ret. 6 mm	✓	✓	✓	✓	✓	✓
	□ Nat. Ret. 6 mm	✓	✓	✓	✓	✓	✓
Azul Macauba	○ Lap. Ret. 10 mm	-	-	✓	✓	-	-
	□ Nat. Ret. 10 mm	-	-	-	-	-	-
	○ Lap. Ret. 6 mm	✓	✓	✓	✓	✓	✓
	□ Nat. Ret. 6 mm	✓	✓	✓	✓	✓	✓
Statuario Splendente	○ Lap. Ret. 10 mm	-	-	✓	✓	-	-
	□ Nat. Ret. 10 mm	-	-	✓	✓	-	-
	○ Lap. Ret. 6 mm	✓	✓	✓	✓	✓	✓
	□ Nat. Ret. 6 mm	✓	✓	✓	✓	✓	✓
Nero Belvedere	○ Lap. Ret. 10 mm	-	-	✓	✓	-	-
	○ Lap. Ret. 6 mm	✓	✓	✓	✓	✓	✓

□ **Naturale e rettificato.** Natural and rectified. Naturel et rectifié. Natur Oberfläche und kalibriert. Natural y rectificado. Натуральный ректифицированный. 天然和拋光。

		GRADINO BORDO DRITTO - STRAIGHT-EDGE STEP					
		160x30x4 h 63°x12°x1 1/2°h	160x30x4 h 63°x12°x1 1/2°h Angolo dx-sx	120x30x4 h 48°x12°x1 1/2°h	120x30x4 h 48°x12°x1 1/2°h Angolo dx-sx	80x30x4 h 31 1/2°x12°x1 1/2°h	80x30x4 h 31 1/2°x12°x1 1/2°h Angolo dx-sx
Bianco Bernini	○ Lap. Ret. 10 mm	-	-	✓	✓	-	-
	□ Nat. Ret. 10 mm	-	-	-	-	-	-
	○ Lap. Ret. 6 mm	✓	✓	✓	✓	✓	✓
	□ Nat. Ret. 6 mm	✓	✓	✓	✓	✓	✓
Calacatta	○ Lap. Ret. 10 mm	-	-	✓	✓	-	-
	□ Nat. Ret. 10 mm	-	-	✓	✓	-	-
	○ Lap. Ret. 6 mm	✓	✓	✓	✓	✓	✓
	□ Nat. Ret. 6 mm	✓	✓	✓	✓	✓	✓
Crema Marfil	○ Lap. Ret. 10 mm	-	-	✓	✓	-	-
	□ Nat. Ret. 10 mm	-	-	✓	✓	-	-
	○ Lap. Ret. 6 mm	✓	✓	✓	✓	✓	✓
	□ Nat. Ret. 6 mm	✓	✓	✓	✓	✓	✓
Statuario	○ Lap. Ret. 10 mm	-	-	✓	✓	-	-
	□ Nat. Ret. 10 mm	-	-	✓	✓	-	-
	○ Lap. Ret. 6 mm	✓	✓	✓	✓	✓	✓
	□ Nat. Ret. 6 mm	✓	✓	✓	✓	✓	✓
Bardiglio Cenere	○ Lap. Ret. 10 mm	-	-	✓	✓	-	-
	□ Nat. Ret. 10 mm	-	-	✓	✓	-	-
	○ Lap. Ret. 6 mm	✓	✓	✓	✓	✓	✓
	□ Nat. Ret. 6 mm	✓	✓	✓	✓	✓	✓
Lasa	○ Lap. Ret. 10 mm	-	-	✓	✓	-	-
	□ Nat. Ret. 10 mm	-	-	✓	✓	-	-
	○ Lap. Ret. 6 mm	✓	✓	✓	✓	✓	✓
	□ Nat. Ret. 6 mm	✓	✓	✓	✓	✓	✓
Azul Macauba	○ Lap. Ret. 10 mm	-	-	✓	✓	-	-
	□ Nat. Ret. 10 mm	-	-	-	-	-	-
	○ Lap. Ret. 6 mm	✓	✓	✓	✓	✓	✓
	□ Nat. Ret. 6 mm	✓	✓	✓	✓	✓	✓
Statuario Splendente	○ Lap. Ret. 10 mm	-	-	✓	✓	-	-
	□ Nat. Ret. 10 mm	-	-	✓	✓	-	-
	○ Lap. Ret. 6 mm	✓	✓	✓	✓	✓	✓
	□ Nat. Ret. 6 mm	✓	✓	✓	✓	✓	✓
Nero Belvedere	○ Lap. Ret. 10 mm	-	-	✓	✓	-	-
	○ Lap. Ret. 6 mm	✓	✓	✓	✓	✓	✓

○ **Lappato e rettificato.** Lappato and rectified. Lappato et rectifié. Lappato und kalibriert. Lappato y rectificado. Лаппатированный ректифицированный. 亚光和拋光。

## IMBALLI

Package . Emballage . Verpackung . Embalajes . Упаковка . 涂料.

FORMATO cm. Size	SPESSORE. Thickness	TIPOLOGIA IMBALLO. Type of packing	LASTRE Slabs	MQ LASTRA Sqm Slab	KG LASTRA Kg Slab	MQ. Sqm	KG Kg	TARA Tare
160x320	6 mm	<b>Cassa / Crate</b> 345x175x37	14	5,12	74,14	71,68	1.178	140,00
		<b>Cavalletto / A-Frame</b> 330x75x193,5	44			225,28	3.472	210,00
160x160	6 mm	<b>Cassa / Crate</b> 182,6x173,6x40,4	24	2,56	37,07	61,44	962	71,80
		<b>Cavalletto / A-Frame</b> 330x75x193,5	88			225,28	3.472	210,00
120x240	6 mm	<b>Cassa / Crate</b> 264x136x40	20	2,88	41,70	57,60	934	100,00
		<b>Cavalletto / A-Frame</b> 250x75x153,5	44			126,72	1.993	158,00
120x120	6 mm	<b>Cavalletto / A-Frame</b> 250x75x153,5	88	1,44	20,85	126,72	1.993	158,00
80x240	6 mm	<b>Cassa / Crate</b> 265x96x47	30	1,92	27,80	57,60	912	78,00
		<b>Cavalletto / A-Frame</b> 250x75x153,5	44			84,48	1.381	158,00
80x160	6 mm	<b>Pallet speciale con sponde / Special pallet with sides</b> 168x97x40,9	30	1,28	18,60	38,40	603	45,00

FORMATO cm. Size	SPESSORE. Thickness	TIPOLOGIA IMBALLO. Type of packing	PZ. X SCAT. Pieces x Box	MQ. X SCAT. Sqm x Box	KG X SCAT. Weight x Box	SCAT. X PAL. Boxes x Pal.	MQ. X PAL. Sqm x Pal.	KG X PAL. Weight x Pal.
120x120	6 mm	<b>Pallet speciale con sponde / Special pallet with sides</b> 143x123x64,7	2	2,88	41,70	24	69,12	1.057
80x80	6 mm	<b>Europallet</b> 80x120	3	1,92	27,90	40	76,80	1.141
60x120	10 mm	<b>Europallet</b> 80x120	2	1,44	33,41	30	43,20	1.025
60x60	10 mm	<b>Europallet</b> 80x120	3	1,08	24,80	40	43,20	1.012

I pesi riportati in tabella sono indicativi in quanto possono subire leggere variazioni per motivi produttivi.  
The weights stated in the chart are approximate as some changes may be necessary for production reasons.  
Les poids figurant dans le tableau sont fournis à titre indicatif car ils peuvent subir de légères variations pour des raisons de production.  
Die in der Tabelle aufgeführten Gewichte sind nicht bindend, da sie aus Produktionsgründen leichte Änderungen aufweisen können.

Los pesos señalados en la tabla son aproximados ya que pueden experimentar ligeras variaciones por motivos productivos.  
Указанный в таблице вес является приблизительным, так как ввиду производственных необходимостей, он может слегка измениться.  
表格记载的重量只具有提示意义，因为可能在生产过程中产生轻微的偏差。

## CERTIFICAZIONI DI PRODOTTO

Product certification . Certification de produit . Produkt Zertifizierungen . Certificaciones de producto . Сертификация . 产品认证 .

100% DESIGN  
AND PRODUCTION  
OF ITALY



放射性水平 A 类

Certificazione obbligatoria per l'esportazione in Cina  
Certification mandatory for export to China  
Certification obligatoire pour l'exportation en Chine  
Für den Export nach China obligatorische Zertifizierung  
Certificación obligatoria para la exportación a China  
Обязательная сертификация для экспорта в Китай

  
Ceramics of Italy



# CARATTERISTICHE TECNICHE

Technical features . Caracteristiques techniques . Technische Eigenschaften . Caracteristicas tecnicas . Технические характеристики . 技术特点 .

## LASTRE IN GRES PORCELLANATO PRESSATE A SECCO. Classificazione secondo UNI EN 14411-ISO 13006 - G - Bla (E ≤ 0,5%) UGL

Dry-pressed porcelain stoneware slabs. Classificazione secondo UNI EN 14411-ISO 13006 - G - Bla (E ≤ 0,5%) UGL













Dalles en grès cérame pressées à sec. Classificazione secondo UNI EN 14411-ISO 13006 - G - Bla (E ≤ 0,5%) UGL

Trockengepresste Platten aus Feinsteinzeug. Classificazione secondo UNI EN 14411-ISO 13006 - G - Bla (E ≤ 0,5%) UGL

Planchas en grés porcelánico prensadas en seco. Classificazione secondo UNI EN 14411-ISO 13006 - G - Bla (E ≤ 0,5%) UGL

Керамогранитные плиты сухого прессования. Classificazione secondo UNI EN 14411-ISO 13006 - G - Bla (E ≤ 0,5%) UGL

干燥压制瓷制砖.

	<b>CARATTERISTICA</b> Specification Caracteristique Eigenschaft Característica Характеристика 功能	<b>METODO DI PROVA</b> Test methods Methode d'essai Testverfahren Prueba Стандарт испытаний 方法测试	<b>VALORE PRESCRITTO</b> Fixed value Valeur prescrite Vorgeschriebener Wert Valor prescrito Требуемое значение 指引	
	<b>Caratteristiche dimensionali</b> - Dimensional characteristics - Dimensions - Dimensionale Eigenschaften Características dimensionales - Пространственные характеристики - 尺寸特性	ISO 10545-2		<b>Conforme</b> Compliant - Conforme - Erfüllt - Cumple Соответствует - 符合性
	<b>Assorbimento d'acqua</b> - Water absorbtion - Absortion d'eau - Wasseraufnahme Absorción de agua - Водопоглощение - 吸水率	ISO 10545-3	≤ 0,5 %	≤ 0,05 %
	<b>Resistenza alla flessione</b> - Breaking modulus - Resistance a la flexion - Biegefestigkeit Resistencia a la flexión - прочность на изгиб - 弯曲强度		≥ 35 N/mm <sup>2</sup>	<b>Conforme</b> Compliant - Conforme - Erfüllt - Cumple Соответствует - 符合性
	<b>Sforzo di rottura</b> - Modulus of rupture - Charge de rupture - Bruchlast - Esfuerzo de rotura Стойкость на изгиб - 断裂应力	ISO 10545-4	≥ 7,5 mm = ≥ 1300 N < 7,5 mm = ≥ 700 N	<b>Conforme</b> Compliant - Conforme - Erfüllt - Cumple Соответствует - 符合性
	<b>Resistenza alla abrasione profonda</b> - Deep abrasion resistance - Resistance a l'abrasion profonde Beständigkeit gegen Tiefenverschleiß - 深层磨损耐性	ISO 10545-6	≤ 175 mm <sup>3</sup>	< 175 mm <sup>3</sup>
	<b>Coefficiente di dilatazione termica lineare</b> - Thermal expansion coefficient - Coefficient de dilatation thermique lineaire - Warmausdehnungskoeffizient - Coefficiente de dilatación térmica lineal зкзоэффициент теплового линейного расширения - 线性热膨胀系数	ISO 10545-8	<b>Metodo disponibile</b> Available on request - Methode disponible Verfügbares Verfahren - Método disponible Определяется производителем - 可行方法	≤ 7x10 <sup>-6</sup> °C <sup>-1</sup>
	<b>Resistenza agli sbalzi termici</b> - Thermal shock resistance - Resistance aux ecart de temperature Temperaturwechselbeständigkeit - Resistencia a choque térmico Устойчивость к температурным перепадам - 抗热震性	ISO 10545-9	<b>Metodo disponibile</b> Available on request - Methode disponible Verfügbares Verfahren - Método disponible Определяется производителем - 可行方法	<b>Resistenti</b> Resistant - Résistants - Widerstandsfähig Resiste - устойчивы - 耐性
	<b>Resistenza al gelo</b> - Frost resistance - Resistance au gel - Frostbestaendigkeit - Resistencia al hielo Морозостойкость - 抗冻性	ISO 10545-12	<b>Richiesta</b> Always tested - Exigee - Notwendig Pedido требования - 申请	<b>Resistenti</b> Resistant - Résistants - Widerstandsfähig Resiste - устойчивы - 耐性
	<b>Resistenza ai prodotti chimici</b> - Chemical resistance - Resistance aux produits chimiques Chemische Beständigkeit - Resistencia a los productos químicos - Химическая устойчивость - 耐化学腐蚀	ISO 10545-13	min. UB	<b>Resistenti</b> Resistant - Résistants - Widerstandsfähig Resiste - устойчивы - 耐性
	<b>Prodotti chimici ad uso domestico ed additivi per piscina</b> - Household chemicals and swimming pool water cleansers - Produits chimiques courants et additifs pour piscine - Chem.Produkte für den Haushaltsgebrauch und Zusatz für Schwimmbäder - Productos químicos para uso doméstico y con aditivos para piscina - бытовые химические средства и средства для бассейнов - 家用化学产品和游泳池添加剂			
	<b>Acidi ed alcali a bassa concentrazione</b> - Acids and low concentration alkalis - Acides et alcali a faible concentration - Säuren und Alkali in geringer Konzentration - Ácidos y álcalis en baja concentración Низкоконцентрированные кислоты и щёлочи - 低浓度下酸碱度			
	<b>Resistenza alle macchie</b> - Stain resistance - Resistance aux taches - Fleckbeständigkeit Resistencia a las manchas - Устойчивость к загрязнению - 耐油污	ISO 10545-14	<b>Metodo disponibile</b> Available on request - Methode disponible Verfügbares Verfahren - Método disponible Определяется производителем - 可行方法	min. 4
	<b>Stabilità dei colori alla luce</b> - Colour stability to light - Stabilité des couleurs a la lumiere Lichtechtheit der Farben - Estabilidad de los colores - Устойчивость цвета - 光颜色牢度	DIN 51094	<b>Metodo disponibile</b> Available on request - Methode disponible Verfügbares Verfahren - Método disponible Определяется производителем - 可行方法	<b>Conforme</b> Compliant - Conforme - Erfüllt - Cumple Соответствует - 符合性
	<b>Coefficiente di attrito (scivolosità)</b> Friction coefficient (slipperiness)	ANSI A 137.1:2012	≥ 0,42	≥ 0,42 <b>Superficie naturale</b> Natural surface

LA FABBRICA S.p.A. si riserva di apportare, senza alcun preavviso, le modifiche che riterrà più opportune al fine di migliorare il prodotto. Quanto riportato è da considerarsi indicativo e non esaustivo in riferimento ai colori e alle caratteristiche estetiche dei prodotti.

LA FABBRICA S.p.A. reserves the right to make any changes it deems fit in order to improve the product, without prior notice. All images are provided for illustrative purposes only and other colours and aesthetic features are available.





**La Fabbrica S.p.A.**

Via Emilia Ponente, 925 - 48014 Castel Bolognese (RA) Italy  
 Tel. +39 0546 - 659911 - Fax +39 0546 - 656223  
[www.lafabbrica.it](http://www.lafabbrica.it) - [info@lafabbrica.it](mailto:info@lafabbrica.it)

DAFIN GROUP



[www.avaceramica.it](http://www.avaceramica.it)



[www.lafabbrica.it](http://www.lafabbrica.it)



[www.iblspa.it](http://www.iblspa.it)

Follow us

